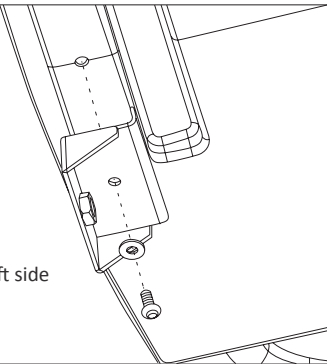

zView Assembly Instructions for zSpace 300

- 1**

Align bracket to M4 threaded hole. Insert and tighten the washer and button head cap screw with provided hex key.

*Instructions are for assembling on left side (referencing facing the display). Please mirror for right side assembly.

- 2**

Thread knurled nut onto the threaded end until flush with bottom.

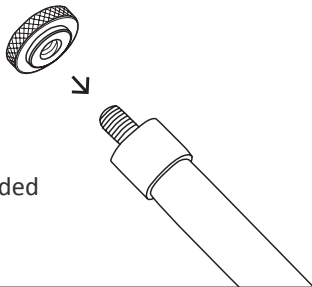
- 3**

On the other end, place lock washer on threads and thread flexible hosing through the bracket's 1/4-20 threaded hole.

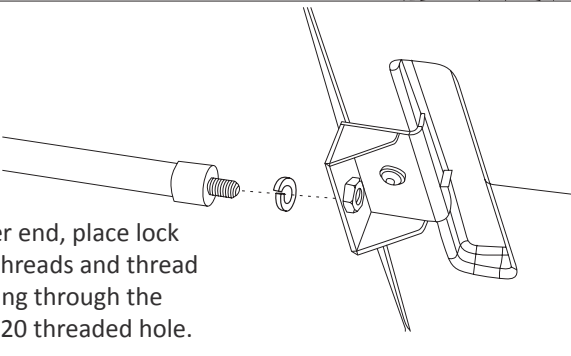
- 4**

Thread knurled nut with flange on the other side until hand tight.

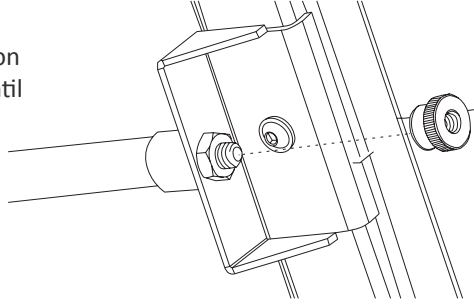
- 5**

Bend flexible hosing to position that will allow webcam to have clear view of user's hand and screen.

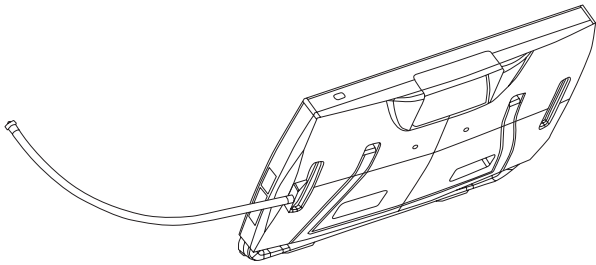
- 6**

For left side mount, have hose biased high. Once webcam is installed, hose will be brought up to fine tune viewing location. In doing so, hose will further tighten on knurled nut.

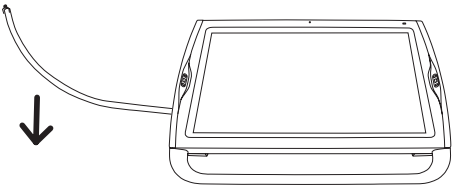
- 7**

For right side mount, have hose biased low. Once webcam is installed, hose will be brought up to fine tune viewing location. In doing so, hose will further tighten on knurled nut.

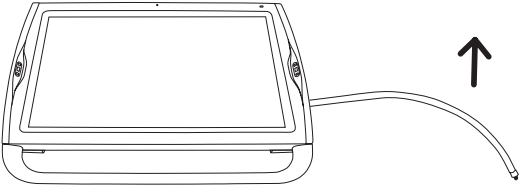
- 8**

Thread webcam onto 1/4"-20 threads.

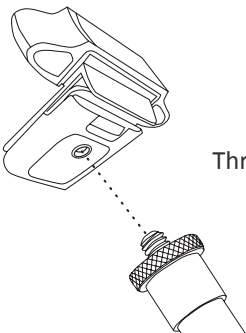

9

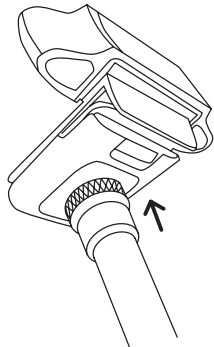

Rotate knurled nut until tight against webcam

10

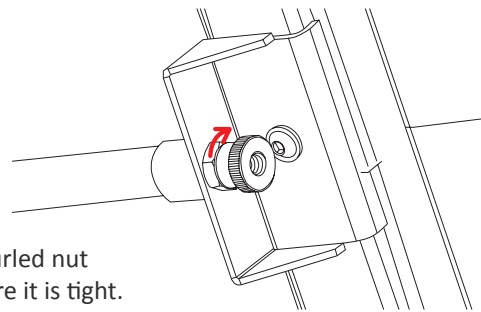

Finally, turn the knurled nut with flange to ensure it is tight.

11

Disclaimer: If you continue to readjust the bend and viewing position of the camera, threaded joint may loosen. Straighten the flexible tubing and retighten the hose's threads onto the bracket before rebending/positioning.

Connect the webcam's USB cable into the display monitor's port. For access to necessary zView Software, please go to zspace.com/login and register for a zSpace account. Upon completion of registration, please send your username to orders@zspace.com to authorize that account for access to zView.