

# PULSARON Threadripper™ PRO Workstation



AMD  
**RYZEN**  
THREADRIPPER

**Workstation Pulsaron**

- Newest AMD Ryzen Threadripper™ PRO processor-technology
- Up to 1-TB DDR-4 ECC memory
- Only highest-quality workstation components used
- Long-term plug & play upgrade capable



## Schneider Digital PULSARON Threadripper™ PRO Workstation

Unlimited possibilities. Breakthrough performance. Robust reliability.

Imagine your company using a workstation system with visualization, computation and design functions that offers an unprecedented, most favorable ratio between price and extreme performance. Schneider Digital has teamed up with AMD to build such a system for you: The PULSARON Threadripper™ PRO workstation with up to four high-performance graphics cards, a 64-core CPU that is optimized for continuous, high-performance use and ISV-certified for multithreaded applications.

**Unrivaled many cores: Made for the fast lane!**

Do you want the ultimate productivity booster? Together with AMD we developed the world's first PULSARON Threadripper™ PRO workstation. This truly unrivaled, fast power machine breaks down the performance limits of conventional single and dual socket workstations and is available from Schneider Digital with all AMD performance features.

Schneider Digital and AMD bring together what belongs together: concentrated 64-core CPU dynamics with 128 threads, connected to high-performance main memory with 3,200 MHz clock speed, which can be expanded to 1-Terabyte ECC RAM. Our motherboard features 7x PCI Express 4.0 x16 slots for ultra-high-end graphics options and the possibility of integrating 18 NVMe mass storage devices with U.2 or M.2 interfaces as internal, noiseless ultra-fast RAID drives. Everything in a compact housing with an optimally dimensioned cooling concept. This means that the ISV-certified PULSARON Threadripper™ PRO workstation is fit for the most complex photogrammetry, rendering and visualization workflows, 8K streaming and (AI) simulation solutions.

The standards for this robust and absolutely reliable top workstation are a multi-level security concept, comprehensive operating and system-independent management functions that can be carried out externally at any time via the iKVM network interface, enabling for example simplified commissioning, imaging, monitoring and control functions, including remote maintenance and real-time monitoring.

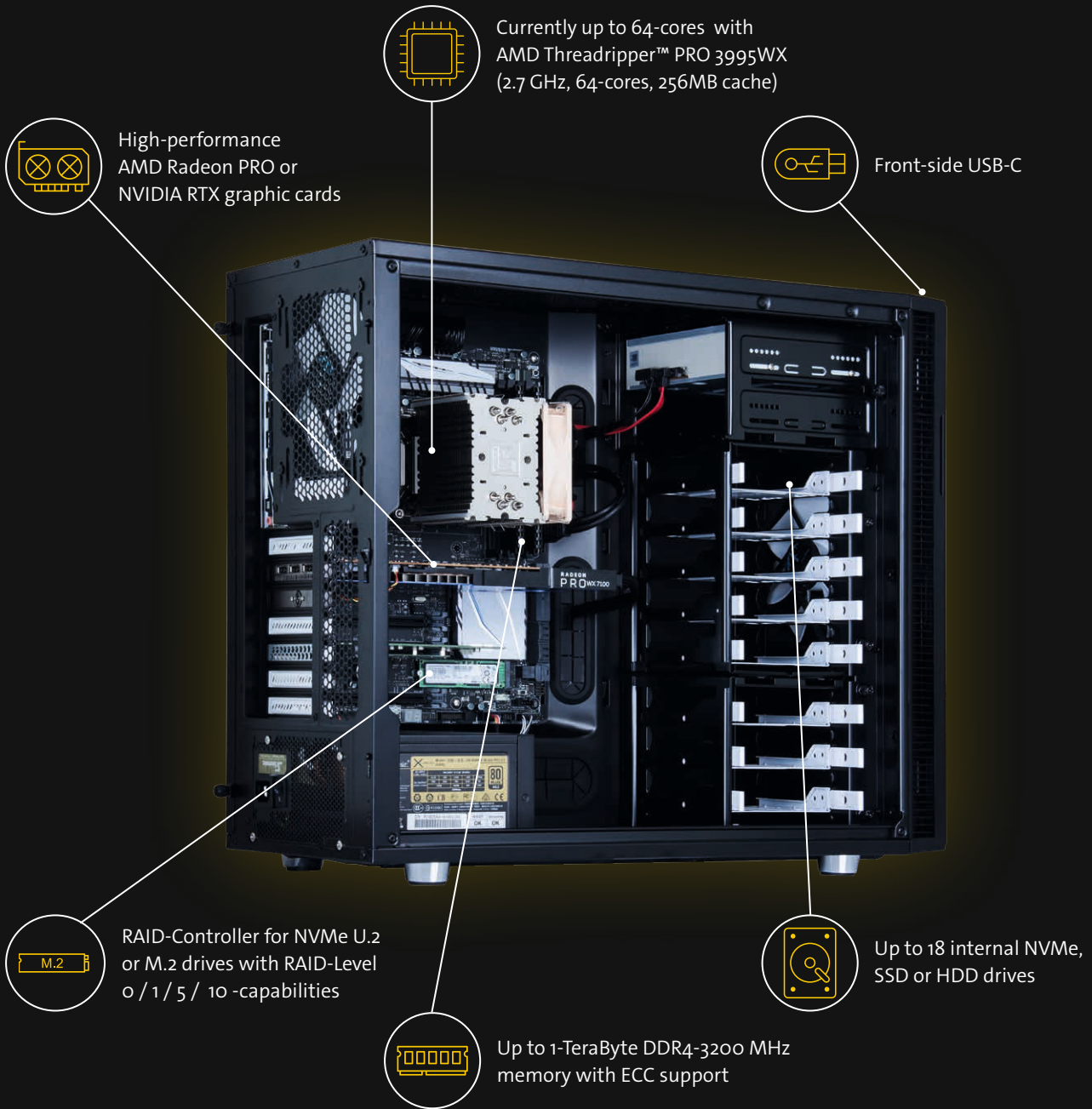

## Key Features

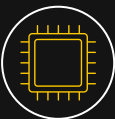

**Ultimate Performance**  
Powered by the latest AMD Threadripper™ PRO CPUs and high-performance AMD Radeon PRO or NVIDIA RTX graphics cards for maximum performance.



**Tested and Certified**  
Tested by independent institutes and certified by software providers (ISVs) for all common applications.



**Industry-leading Continuity**  
Proven industry leader for workstation reliability with many long-term customers on all continents.



**Customer-oriented Innovation**  
Ingenious modular structure and tool-free access allow effortless upgrades and adjustments.



**Extensive Solutions Competence**  
Extended support for the latest technologies, such as AI and VR/AR, as well as software tools for performance optimization.



**Highest Security**  
Built with advanced, comprehensive software technologies for ultimate security.

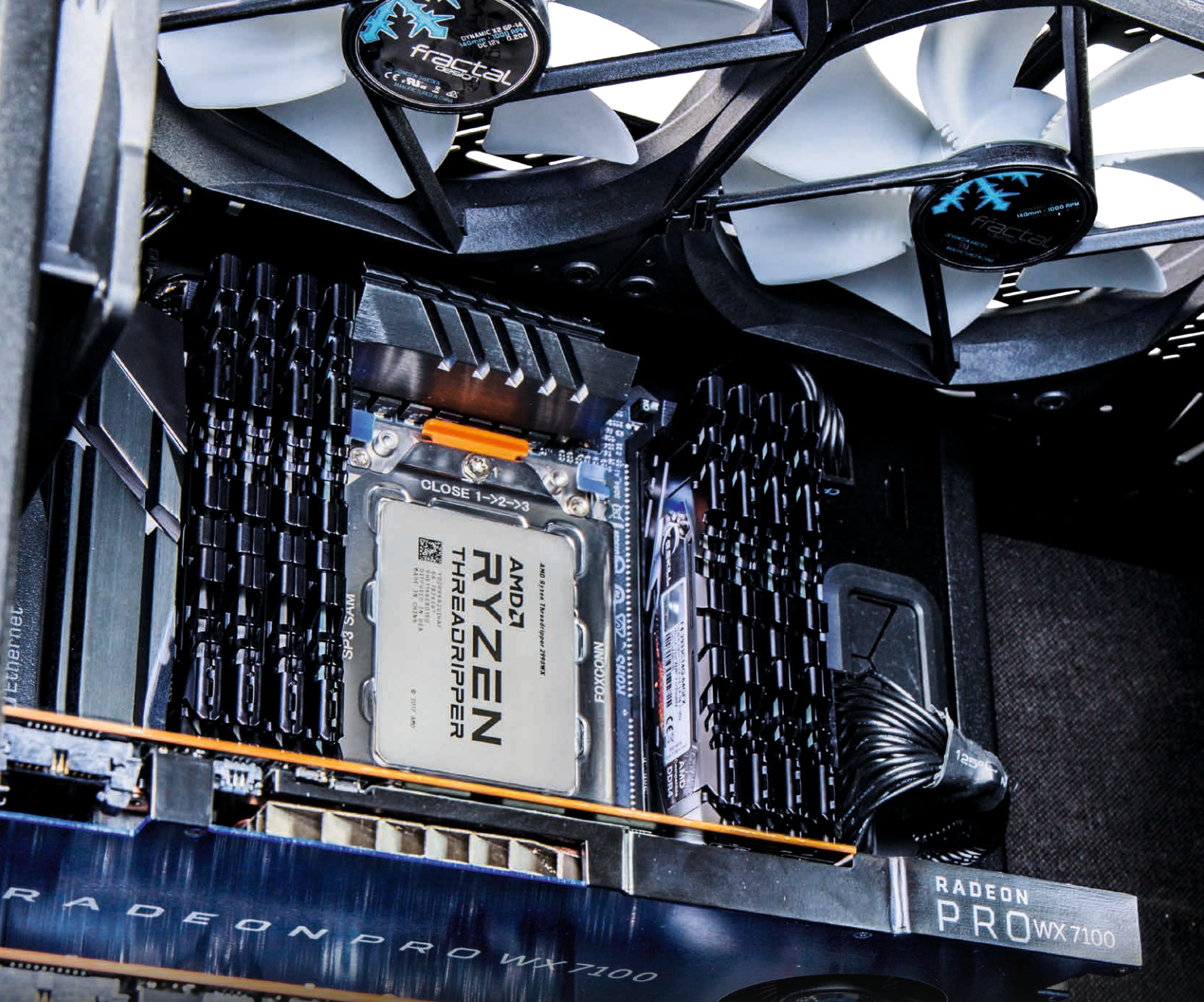

## Performance and security like never before

Enterprise-class features for seamless security, manageability and support

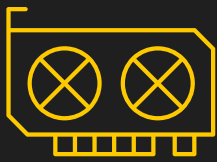

### Maximum Graphics Performance

Benefit from extensive configuration options. Add up to four high-end or ultra-high-end AMD Radeon PRO or NVIDIA RTX graphics cards to maximize GPU-based solutions.



### Maximum Security

Protect your important data with Memory Guard encryption, with Secure Boot, and much more for the ultimate in security in your daily workflow.



### Maximum Reliability

AMD PRO Manageability, together with our professional remote services, enable updates and fixes, as well as the monitoring, restoration and updating of your system.

# Performance Characteristics



## Unbeatable Performance

Give your next professional workstation the ultimate productivity boost and configure it with the fastest workstation processor available today. The concentrated 64-core (128 threads) power of the AMD Threadripper™ PRO 3995WX processor shatters the performance limits of the most powerful single-socket workstations and even outperforms dual-socket systems with more cores in total. With impressive base clock rates of up to 4.0 GHz and up to 4.3 GHz in Turbo Boost, Threadripper™ PRO processors ensure maximum performance in both single and multithreaded applications, enabling the shortest rendering times, more creative iterations and lightning-fast simulations. The PULSARON Threadripper™ PRO workstation supports PCI-Express 4.0: With 128 PCI lanes, twice as much bandwidth is available than with the predecessor PCIe 3.0 for the connection of graphic cards and extremely fast, next-generation storage media.



## Maximum Performance - tailored for you

The Schneider Digital PULSARON Threadripper™ PRO workstation is fully configurable: From memory and data storage to numerous expansion slots and enterprise-class AMD Ryzen™ PRO administration and security functions, the workstation offers more than enough scope to optimize and tailor it exactly to your needs. Use up to four AMD Radeon Pro W6800 with 32GB RAM each, or four NVIDIA RTX A6000 with 48GB RAM each, to execute GPU-based workflows at maximum efficiency for artificial intelligence (AI), photogrammetry, or computer-generated imaging (CGI) applications.



## Power ,on the rocks': well cooled and easy to maintain

To provide the necessary cooling, a specially adapted system of heat sinks and fans was developed by Schneider Digital for the PULSARON Threadripper™ PRO workstation. This ensures the optimal working temperature of the components at all times and enables the generally very low noise levels to remain in the background, even under full load - until the job is done.



## ISV-certified and fit for the most complex tasks

The Schneider Digital PULSARON Threadripper™ PRO Workstation is certified by independent software providers (ISVs) and can be used in all industries, for example for geosciences, in architecture, engineering and construction, in the media and entertainment industry, for medical applications, in biosciences, in the oil, gas and energy sectors, in finance and in the fields of ,Artificial Intelligence' and ,Virtual Reality'. It is perfect for computationally intensive multithreading applications, especially those used in the 3D graphics area for visualization and modeling, for geospatial data analysis, in architecture and BIM, mechanical engineering, the entire science sector, for simulation and for VR applications.



## Complete protection. Smart security functions.

The integrated security software and the multi-level AMD PRO security concept provide protection against even sophisticated attacks. Thanks to AMD Memory Guard and AMD Secure Processor technology, hackers stay out!

A dedicated ,Trusted Platform Module' (TPM) protects the entire system and your data from manipulation. Among other things it ensures, that Windows BitLocker safely encrypts your data. Serial, parallel, USB, audio and network connections can also be deactivated - an additional protection against uninvited visitors. In addition, you can set a BIOS password and a power-on password and additionally restrict and control access to the system at the most fundamental level.

Independent benchmark tests certify the PULSARON Threadripper™ PRO workstation maximum performance, for instance for the following software applications:





## Maximum power for all professional applications and areas of use



### Geodata Processing

To process extreme amounts of data reliably and as fast as possible, even in the high Tera- or PetaByte range, the highest computing power and hardware reliability is required. This is already essential for the processing of high-resolution, multi-view aerial images or LiDAR point clouds, covering entire cities and regions. For such tasks, the PULSARON Threadripper™ PRO workstation is uncompromisingly designed for stability and maximum performance.



### Manufacturing and Product Development

The Schneider Digital PULSARON Threadripper™ PRO workstation is perfect for complex CAD applications and processor-intensive CAE workflows: it offers the highest cycle rates for solid modeling where a large number of cores are required for generative design, simulation, visualization and CAM. It delivers the power you need to design and validate concepts!



### Architecture, Engineering and Construction

Don't wait any longer, run AEC and BIM applications much faster with the Schneider Digital PULSARON Threadripper™ PRO workstation! Architects, designers and engineers can choose clock rates of up to 4.3GHz and powerful graphics cards for faster modeling and rendering.



### Health & Medical

The Schneider Digital PULSARON Threadripper™ PRO workstation is equipped with a high number of cores and the highest clock rates to accelerate forecast models, data analytics and simulations, supporting for instance drug research for the development of life-saving drugs and vaccines. In prosthetics, it is used in the construction and validation of precisely fitting endoprostheses or exoprostheses and supports the specialist with minimal computing times for construction, simulation and validation.



### Media and Gaming

Whether 3D animation, compositing, image processing, creative finishing or rendering – a Schneider Digital PULSARON Threadripper™ PRO Workstation offers the highest clock rates thanks to AMD Threadripper™ PRO processors with 12, 16, 32 or 64 cores, allowing you to realize your creative vision.



### Financial Analysis

The Schneider Digital PULSARON Threadripper™ PRO workstation offers an optimally balanced ratio between GHz per CPU and number of cores in order to meet the high demands of stock market analysts, investment bankers and financial market professionals in terms of performance and productivity, enabling minimum latency for the real-time analysis of data models.



### Artificial Intelligence (AI)

From model training, machine learning and deep learning to inferencing, edge computing and quantization: With the Schneider Digital PULSARON Threadripper™ PRO workstation, data scientists can switch seamlessly, quickly and efficiently between high CPU and GPU performance for demanding, heterogeneous AI workflows.

# Workstation Pulsaron

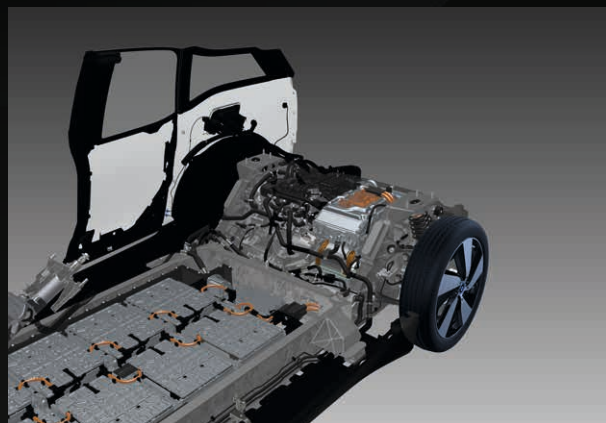
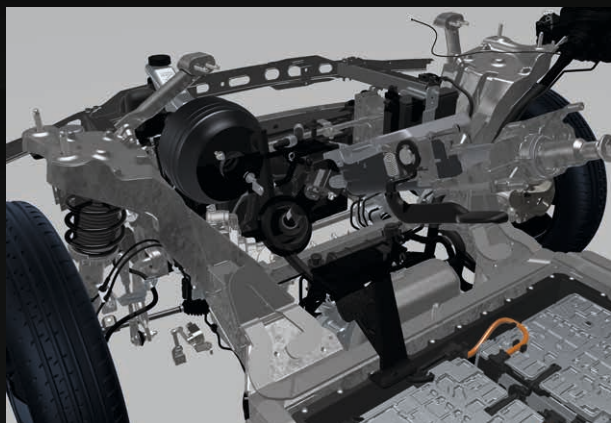



# Manufactory workstations - tailor-made for your requirements

The Schneider Digital PULSARON Threadripper™ PRO workstations are based on high-quality motherboards with AMD processors of the latest Ryzen™ Threadripper generation and 128 PCI-Express lanes. Supporting the current PCIe 4.0 standard, AMD Threadripper™ PRO motherboards achieve I/O transfer rates that were previously unattainable. They are therefore ideally suited for demanding software applications in the area of geodata processing and stereoscopic-interactive 3D representation, medical 3D modeling, in the area of Computer-Generated Imaging (CGI) and for other high-quality rendering and visualization tasks, especially in real-time.

As a manufacturer of professional workstations, we see ourselves as 'tuners' for the speed of your software. We offer our customers tailor-made solutions with workplace-specific system design, tailored to your software applications and application requirements. In particular, we can also adapt the housing to your requirements. The user not only gets the maximum performance for his daily work, but also a future-proof workplace solution where it is possible to upgrade individual components very easily later on.



## Superior Reliability & Performance

The workstations of the PULSARON series with their groundbreaking AMD Threadripper™ PRO and the professional AMD Radeon PRO and NVIDIA Quadro® RTX graphics cards offer impressive performance, regardless of the task. Our PULSARON workstations have been certified by independent software providers (ISVs), are energy efficient and extremely versatile. They offer you the high level, what you can rightfully expect from Schneider Digital solutions.



## Big workloads? Child's play!

These high-performance workstations have proven in numerous tests that they can handle the most demanding applications and provide the required high level of service. When buying a PULSARON workstation, the ISV certifications assure you can be certain it will perfectly meet the requirements of your company and your industry.



## Suitable for every Workplace

The unsurpassed computing power of our PULSARON workstation series ensures reliable productivity - whether you are creating complex models, performing photo-realistic rendering or analyzing geophysical and seismic 3D-models. From the world's smallest workstations to space-saving compact desktops and towers - our workstations fit perfectly to your workplace.

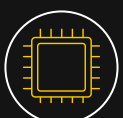

## Maximum Attention to Detail

When building a workstation, we ensure that all workstation components are of the highest quality and are perfectly matched to one another. A workstation can only be as good as the weakest link in the chain of components. Our many years of manufacturing experience allow us to optimally select all components for your workstation, resulting in consistent, maximum workstation performance with the highest reliability. To further increase reliability, each workstation undergoes an intensive burn-in procedure and an associated, fully documented determination of all relevant performance indicators.

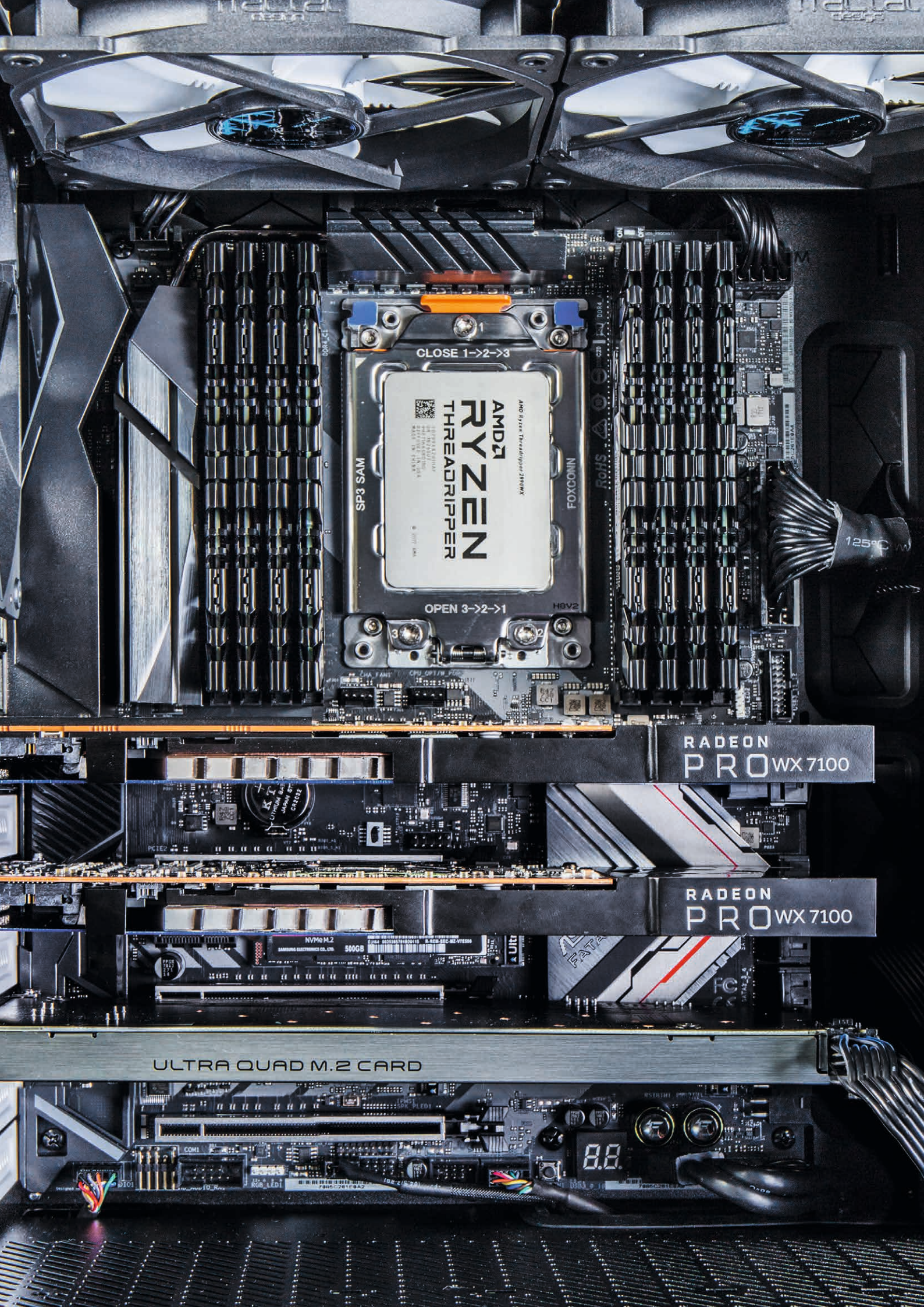

CLOSE 1→2→3

AMD  
**RYZEN**  
THREADRIPPER

SP3 SAM

FOXCONN

H5V2

OPEN 3→2→1

RADEON  
PRO WX 7100

RADEON  
PRO WX 7100

ULTRA QUAD M.2 CARD

8.8

# Upgrade for even more performance



## Maximum Performance

Simply upgrade your Schneider Digital PULSARON workstation by adding components for even more performance or 'plug & play' exchange components / internal hardware to enhance graphic capabilities, expand memory or data storage. By combining these options, you get an even more powerful PULSARON workstation.



## Harddrives

We always configure our workstations with a separate, fast NVMe solid-state drive for the system partitions and the operating system. This speeds up the boot process and simplifies all maintenance, update and backup functions. The use of solid-state disks for data storage on your PULSARON workstation also provides the highest data transfer rates due to the fast PCIe 4.0 interface. Expand the data storage on your PULSARON workstation with additional 8-TB NVMe M.2. or 16-TB U.2 NVMe SSDs or Enterprise 18-TB SATA HDDs.



## Memory

The capacity of the main memory can be expanded by simply plugging-in additional modules or replacing the existing modules without tools. Overall, it can be scaled up to 1 TeraByte to load even your most demanding data sets, models and calculations that have the greatest demands for memory and therefore maximize computation speeds.



## NVMe RAID Solutions

Benefitting from seven (7) PCIe 4.0 16x slots on the motherboard, up to 16 ultra-fast U.2 NVMe SSDs, each with 16-TB storage, can be interconnected via special adapter cards. Combined in a striped RAID-0 array, currently 256-TB of storage space can be achieved with data transfer rates of well over 25,000 MB/s!



## Professional Radeon PRO graphic cards from AMD, with professional driver optimization

Our performance workstations are characterized by graphics solutions, specially tailored to your software application. Regardless of whether geodata is to be processed with ArcGIS Pro, Trimble-INPHO, Summit Evolution, HxMap, or constructions created with AutoCAD, CATIA or SolidWorks - we know the optimal graphics card for your application. Consequently, we can configure every performance workstation individually with optimal Radeon PRO Professional graphics cards from AMD, including driver optimization.

The right choice of graphic cards very often determines the achievable productivity of your application. With 32-GB of super-fast HBM2 ECC RAM, OpenGL 4.6 support and 4,096 OpenCL-capable, parallel processing units, the AMD Radeon PRO W6800 delivers unprecedented performance and scalability, allowing extremely large amounts of data to be analyzed and visualized.

With unbelievable performance values and a price level of only €650, the AMD Radeon PRO W6600 is the bright, new 'star in the sky' of mid-range professional graphics cards. Correctly configured by us, it ensures a substantial performance boost, even in an existing workstation, for the visualization of your specific application. With the new, sustainable AMD RDNA™ 2 driver architecture, the performance values of your workstation can be perfectly transferred to your software application.

Every quarter, AMD reliably releases new Enterprise-RDNA™ 2 drivers that are really packed with features. With the current version, the performance of the existing graphics hardware can even be doubled in many areas! The use of the correct driver is particularly important, as the full performance potential of a professional graphics card can only be achieved, if there is a seamless interaction between the graphics card driver and the application being used. Only constant optimization of the drivers leads to smooth functioning with optimal results, explaining the immense development effort of graphics card manufacturers.

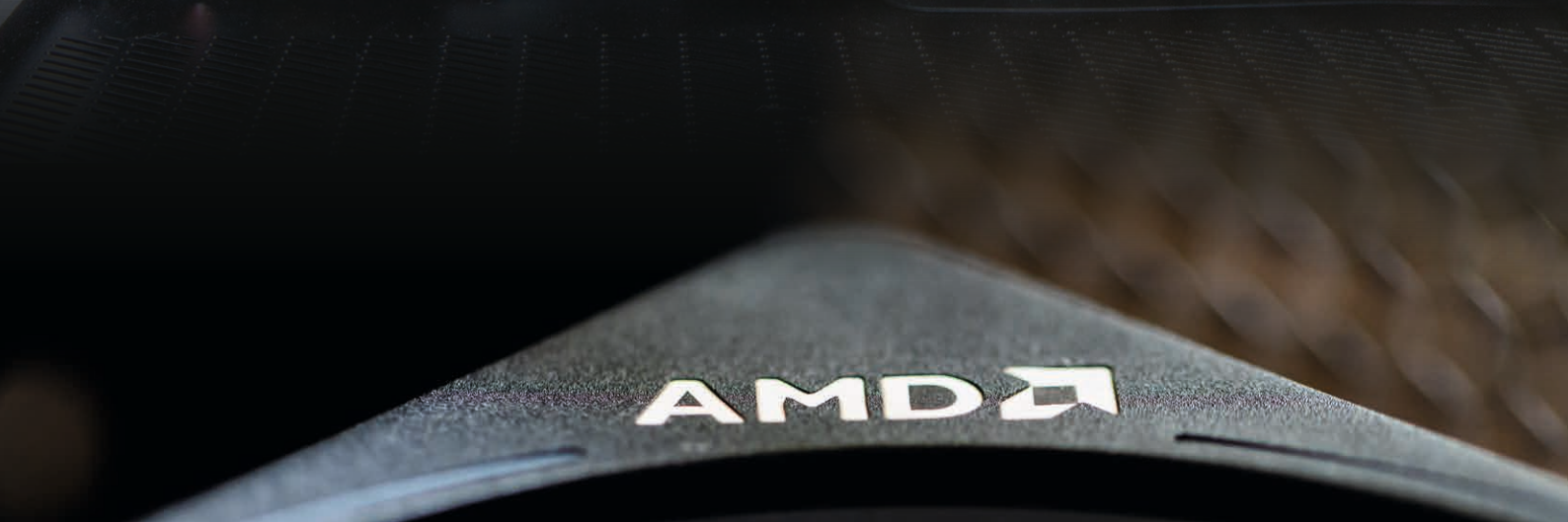
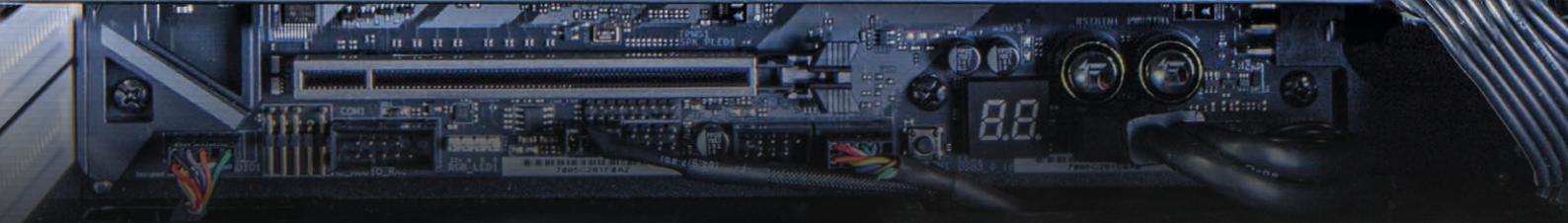
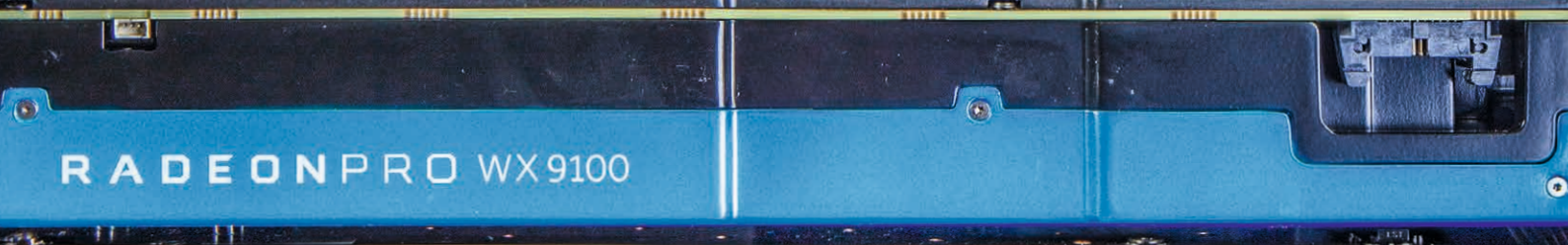
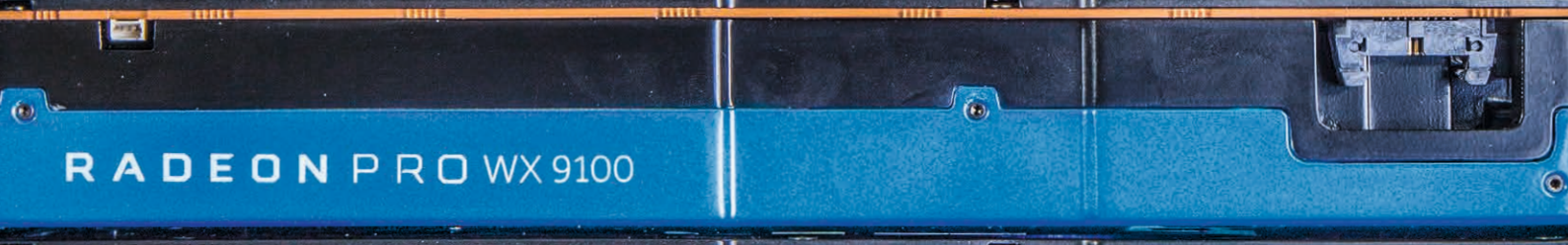
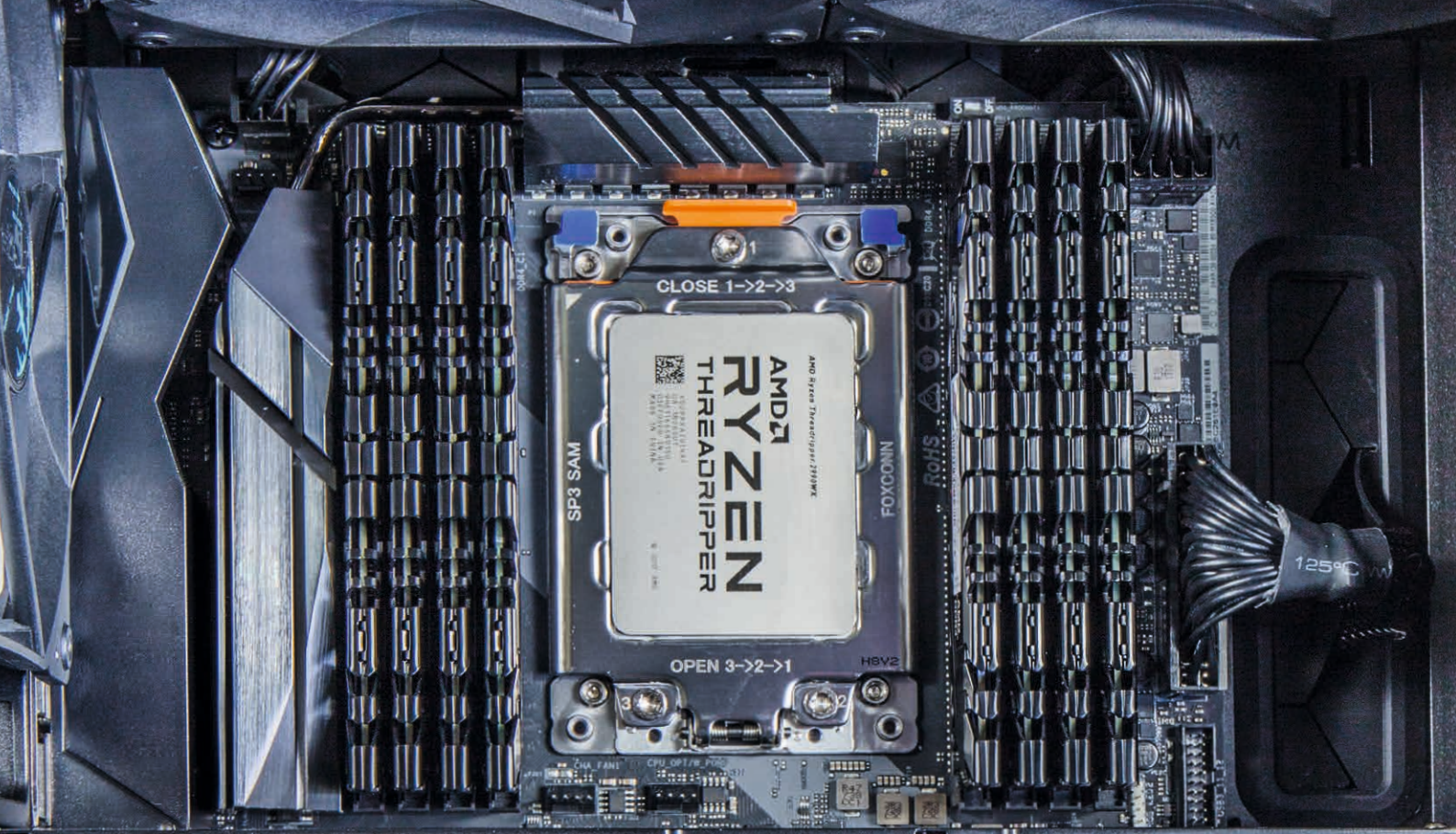



## Expand to a complete workplace solution

Expand your PULSARON workstation with additional hardware components to create a complete workplace solution, regardless of whether it is about additional input devices, a high-end monitor for CAx applications, a PluraView 3D-stereo desktop display, or a VR Powerwall. Your PULSARON workstation is the potent center for all professional and demanding 3D/VR visualizations, rendering, calculation, analysis or modeling - today and in the future.

### 3D Controllers & Input Devices

3D controllers enable comfortable and natural interaction with digital content in the most popular 3D and creative applications, allowing you to concentrate fully on your actual task. The positioning of models or views and the access to preferred application commands take place via the 3D-controller, so that the standard mouse can again serve its original purpose - selecting, editing and creating objects. This coordinated way of working is not only pleasant, but also increases productivity and - due to reduced mouse use - increases the comfort factor.

### 2D Professional Monitors

A high-end monitor, such as the ultrawide and curved 5K UltraSharp WUHD monitor (5120 x 2160 pixels) with a 40-inch screen diagonal, is ideal for productive work. It has a brilliant, 102cm wide display with IPS technology for a wide viewing angle. With a color depth of 1.07 billion colors, it is perfect for professionals who have to rely on color accuracy, covering 100% of sRGB color space.

### 3D-Stereo Monitors and VR Powerwalls

Razor-sharp rendition in 3D stereo, from desktop monitors to Powerwalls: real spatial perception is helpful in every phase of 3D modelling. Collisions are easy to spot, and 3D simulations are perceived realistically. Fatigue-free work in 3D-stereo mode, even over many hours, has already proven itself to be easily achievable in practice. The stereoscopic 28" PluraView monitor with double 4K resolution is large enough even for group presentations, enabling several users to view 3D-stereo at the same time. In product demonstrations or presentations, a stereoscopic display helps to grasp function and design more intuitively. More information at [www.pluraview.com](http://www.pluraview.com).

Of course, we also feature other high-resolution 3D-monitors with 4K resolution and up to 100" diagonal in our portfolio, right up to stereoscopic VR Powerwalls with 6K resolution and an area-size of 12m<sup>2</sup>. In this case, even large objects can be represented in a 1:1 scale and ideas can be impressively represented in design and execution.

# Technical Specifications <sup>(1)</sup>

Processor	High-end AMD CPU, max. AMD Ryzen™ Threadripper PRO 3995WX (2,7 GHz, 64-cores, 256 MB cache)																																
Operating Systems	Windows 10 Pro / Windows Pro for Workstation / Server 2019 / Server 2022 Ubuntu® Linux® Red Hat® Enterprise Linux® (certified)																																
Housing	Attractive, robust aluminum construction Efficient, silent ventilation concept Simplified access to components and clear cable routing																																
Memory	Up to 256GB DDR4-3200MHz unbuffered DIMM with or without ECC Up to 1-TB DDR4-3200MHz registered DIMM with ECC 8 DIMM slots																																
Expansion slots	7x native PCIe 4.0 x16 3x PCIe 4.0 NVMe M.2 2x U.2 (NVMe or SATA)																																
Storage	max. 8x SATA 18-TB HDDs max. 18x NVMe 8-TB M.2 SSDs max. 18x NVMe 16-TB U.2 Datacenter SSDs Optionally configurable as RAID-Level 0 / 1 / 5 / 10																																
Graphics	<table border="0"> <tr> <td>NVIDIA RTX A6000</td> <td>AMD Radeon PRO W6800</td> </tr> <tr> <td>NVIDIA RTX A5000</td> <td>AMD Radeon PRO W6600</td> </tr> <tr> <td>NVIDIA RTX A4000</td> <td>AMD Radeon PRO W5700</td> </tr> <tr> <td>NVIDIA T1000</td> <td>AMD Radeon PRO W5500</td> </tr> <tr> <td>NVIDIA T600</td> <td>AMD Radeon PRO WX3200</td> </tr> <tr> <td>NVIDIA T400</td> <td>AMD Radeon PRO WX2100</td> </tr> </table>			NVIDIA RTX A6000	AMD Radeon PRO W6800	NVIDIA RTX A5000	AMD Radeon PRO W6600	NVIDIA RTX A4000	AMD Radeon PRO W5700	NVIDIA T1000	AMD Radeon PRO W5500	NVIDIA T600	AMD Radeon PRO WX3200	NVIDIA T400	AMD Radeon PRO WX2100																		
NVIDIA RTX A6000	AMD Radeon PRO W6800																																
NVIDIA RTX A5000	AMD Radeon PRO W6600																																
NVIDIA RTX A4000	AMD Radeon PRO W5700																																
NVIDIA T1000	AMD Radeon PRO W5500																																
NVIDIA T600	AMD Radeon PRO WX3200																																
NVIDIA T400	AMD Radeon PRO WX2100																																
Network	Intel® X550-AT2 Dual 10Gb Ethernet Intel® Wi-Fi 6 AX200 Bluetooth v5.1																																
Connectors	<b>Front:</b> 2x USB-A 2.0 2x USB-A 3.2 Gen 1 1x USB-C 3.2 Gen 2 Microphone & Headset combined <b>Back:</b> 2x USB-A 3.2 Gen 2 1x USB-C 3.2 Gen 2 1x USB-C 3.2 Gen 2x2 2x RJ45 10-Gbit/s-Ethernet 5x Audio Ausgang 1x Optical S/PDIF																																
Security	Trusted Platform Module (TPM 2.0) Port deactivation for serial, parallel, USB, audio and network connections Power-on password BIOS-Setup-password																																
ISV certifications	<table border="0"> <tr> <td>Adobe®</td> <td>ESRI®</td> <td>Cardinal Systems®</td> </tr> <tr> <td>Altair®</td> <td>Hexagon®</td> <td>Aplitop®</td> </tr> <tr> <td>Autodesk®</td> <td>Trimble®</td> <td>KLT®</td> </tr> <tr> <td>AVEVA®</td> <td>BAE Systems®</td> <td>Racurs®</td> </tr> <tr> <td>AVID®</td> <td>Vexcel®</td> <td>Halliburton®</td> </tr> <tr> <td>Bentley®</td> <td>DAT/EM®</td> <td>Schlumberger®</td> </tr> <tr> <td>Dassault®</td> <td>Agisoft®</td> <td>Baker Hughes®</td> </tr> <tr> <td>Nemetschek®</td> <td>Terrasolid®</td> <td>Carlson®</td> </tr> <tr> <td>PTC®</td> <td>Vexcel®</td> <td>HIS Markit®</td> </tr> <tr> <td>Siemens®</td> <td>IGI®</td> <td>China NB®</td> </tr> </table> More about specific ISV certifications			Adobe®	ESRI®	Cardinal Systems®	Altair®	Hexagon®	Aplitop®	Autodesk®	Trimble®	KLT®	AVEVA®	BAE Systems®	Racurs®	AVID®	Vexcel®	Halliburton®	Bentley®	DAT/EM®	Schlumberger®	Dassault®	Agisoft®	Baker Hughes®	Nemetschek®	Terrasolid®	Carlson®	PTC®	Vexcel®	HIS Markit®	Siemens®	IGI®	China NB®
Adobe®	ESRI®	Cardinal Systems®																															
Altair®	Hexagon®	Aplitop®																															
Autodesk®	Trimble®	KLT®																															
AVEVA®	BAE Systems®	Racurs®																															
AVID®	Vexcel®	Halliburton®																															
Bentley®	DAT/EM®	Schlumberger®																															
Dassault®	Agisoft®	Baker Hughes®																															
Nemetschek®	Terrasolid®	Carlson®																															
PTC®	Vexcel®	HIS Markit®																															
Siemens®	IGI®	China NB®																															
Environmental certifications	RoHS compliant 80 PLUS® GOLD																																
Dimensions (H x W x D)	604 x 240 x 566 mm																																
Weight (max. configuration)	24 kg																																
Power Supply	1300 Watt 80 Plus Gold certification Fully modular wiring																																

<sup>(1)</sup> Technical data may vary depending on the region / model

## Connections / slots

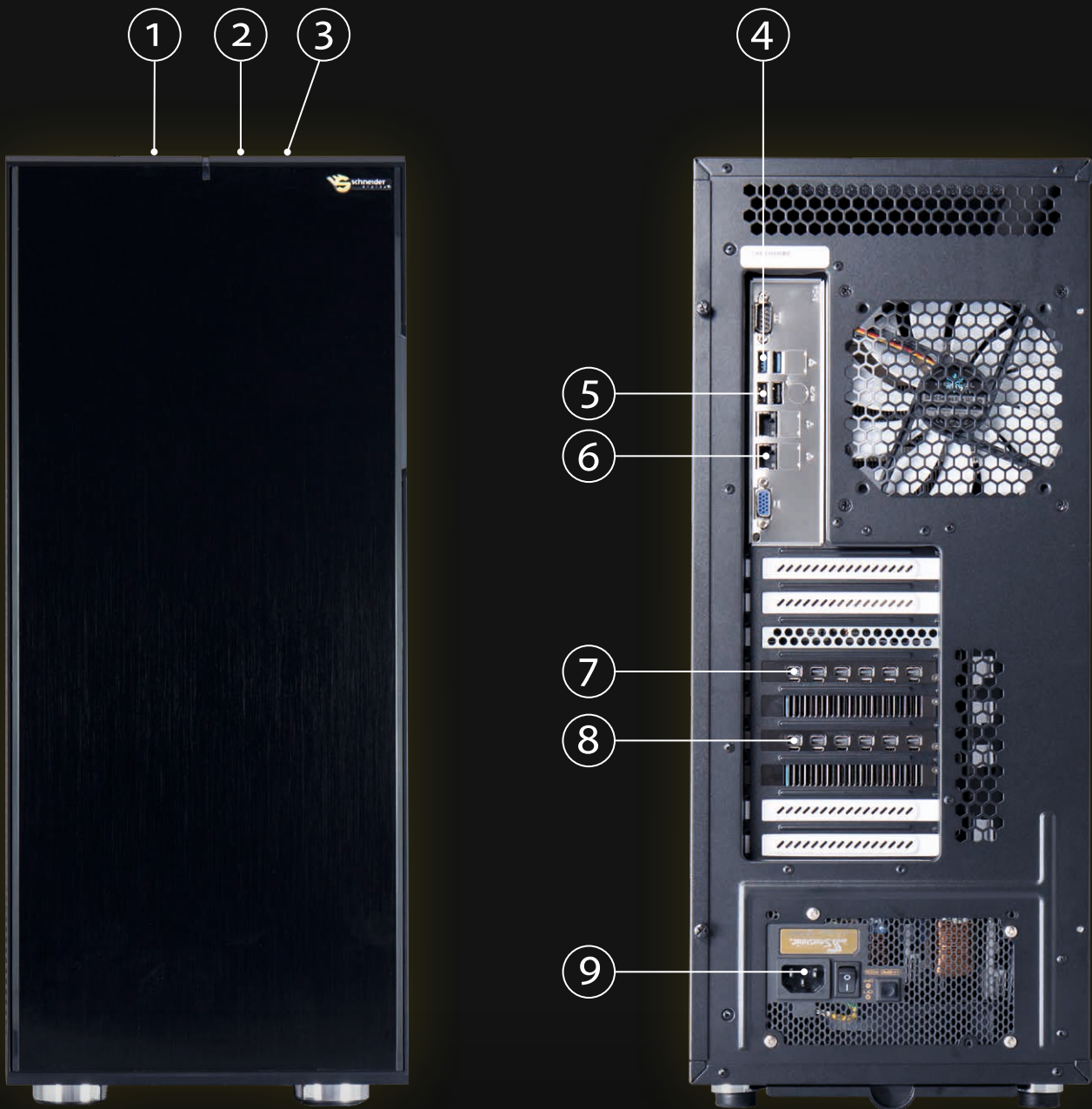

1 Microphone/Headset connector

2 2x USB 2.0 / 2x USB-A 3.2 Gen1

3 1x USB-C 3.2 Gen1

4 1x USB-C 3.2 Gen2 / 1x USB-C 3.2 Gen2x2

5 2x USB-A 3.2 Gen2

6 Dual 10-Gbit/s Ethernet connectors

7 6x Mini-Display-Port

8 6x Mini-Display-Port

9 Power socket

AMD  
**RYZEN**  
THREADRIPPER



 **schneider**  
d i g i t a l

SCHNEIDER DIGITAL  
Josef J. Schneider e.K.  
Maxrainer Straße 10  
D-83714 Miesbach

Tel.: +49 (8025) 9930-0  
Fax: +49 (8025) 9930-299  
[www.schneider-digital.com](http://www.schneider-digital.com)  
[info@schneider-digital.com](mailto:info@schneider-digital.com)