



PS4652/PS5552/PS6552

USER'S GUIDE

www.planar.com

The information contained in this document is subject to change without notice. This document contains proprietary information that is protected by copyright. All rights are reserved. No part of this document may be reproduced, translated to another language or stored in a retrieval system, or transmitted by any means, electronic, mechanical, photocopying, recording, or otherwise, without prior written permission.

Windows is a registered trademark of Microsoft, Inc.

Other brands or product names are trademarks of their respective holders.

Important Recycle Instruction:

This product may contain electronic waste that can be hazardous if not disposed of properly. Recycle or dispose in accordance with local, state, or federal Laws. For more information, contact the Electronic Industries Alliance at WWW.EIAE.ORG.

Revision Control	
DATE:	DESCRIPTION:
<i>July 2015</i>	<i>Document number 020-1239-00 Rev. B.</i>

Table of Contents

Safety warnings and precautions	3
Important safety instructions	4
Notes on the LCD panel of this display	4
Safety notice for remote control	5
Battery safety notice	5
Package contents	6
Setting up the display	7
Mounting the display	7
Installing the display on a wall	7
Parts of the display and their functions	8
Rear panel	8
Input/output terminals	9
Remote control	11
Using the remote control	12
Installing remote control batteries	12
Remote control usage tips	12
Connection.....	13
Connecting audio/video signals.....	13
Connecting the VGA input.....	13
Connecting the YPbPr component video input.....	14
Connecting the DVI-D digital input	15
Connecting the HDMI digital input	16
Connecting the DisplayPort (DP) digital input	17
Connecting multiple displays	18
Connecting power.....	19
Basic operations	20
Turning the display on or off	20
Locking/unlocking the controls.....	20
Switching input signals.....	20
Adjusting audio volume level.....	20
Network connection.....	21
Connecting the display to a local area network.....	21
Remote network control	22
Information	22
Picture & Sound	23
Screen	23
Setting	24
Schedule	24
Mail Report	25
Network	29
RS232 commands over the network.....	30
The OSD (On-Screen Display) menu	31

OSD menu overview	31
Operations in the OSD menu.....	33
Picture menu	34
Sound menu	35
Screen menu	36
Setting menu	38
Viewing multimedia contents	40
Multimedia control buttons on the remote control.....	40
Viewing files	41
Viewing files in the display's built-in memory	41
Viewing files on an external USB storage device	41
Supported file formats.....	41
Settings	52
Product information.....	53
Specifications.....	53
Dimensions.....	55
Remote control codes	58
Supported input signal resolution.....	59
Supported PAP input signal combination	61
Troubleshooting	62

Safety warnings and precautions



The lightning flash with arrowhead symbol, within an equilateral triangle, is intended to alert the user to the presence of uninsulated "dangerous voltage" within the product's enclosure that may be of sufficient magnitude to constitute a risk of electric shock to persons.



The exclamation point within an equilateral triangle is intended to alert the user to the presence of important operating and maintenance (servicing) instructions in the literature accompanying the appliance.

THIS EQUIPMENT MUST BE GROUNDED

To ensure safe operation, the three-pin plug must be inserted only into a standard three-pin power outlet which is effectively grounded through normal household wiring. Extension cords used with the equipment must have three cores and be correctly wired to provide connection to the ground. Wrongly wired extension cords are a major cause of fatalities.

The fact that the equipment operates satisfactorily does not imply that the power outlet is grounded or that the installation is completely safe. For your safety, if you are in any doubt about the effective grounding of the power outlet, please consult a qualified electrician.

- The mains plug of the power supply cord shall remain readily operable. The AC receptacle (mains socket outlet) shall be installed near the equipment and shall be easily accessible. To completely disconnect this equipment from the AC mains, disconnect the power cord plug from the AC receptacle.
- Do not place this display on an uneven, sloping or unstable surface (such as a trolley) where it may fall and cause damage to itself or others.
- Do not place this display near water, like a spa or pool, or in a position which will allow the splashing or spraying of water onto the display, like in front of an open window where rain water may enter.
- Do not install this display in a confined space without proper ventilation and air circulation, such as in a closed cabinet. Allow proper space around the display for dissipating heat inside. Do not block any openings and vents on the display. Overheating may result in hazards and electric shock.
- Installation of this display should only be performed by a qualified technician. Failure to install this display properly may cause injuries and damages to the personnels and the display itself. Check the installation regularly and maintain the display periodically to ensure the best working condition.
- Use only the accessories approved or recommended by the manufacturer to mount this display. Using wrong or unsuitable accessories may cause the display to fall and result in serious personal injuries. Make sure that the surface and fixing points are strong enough to sustain the weight of the display.
- To reduce the risk of electric shock, do not remove covers. No user serviceable parts inside. Refer servicing to qualified service personnel.
- To prevent personal injuries, mounting the display or installing desktop stands is required before use.

Important safety instructions

1. Read these instructions.
2. Keep these instructions.
3. Heed all warnings.
4. Follow all instructions.
5. Do not use this apparatus near water.
6. Clean only with dry cloth.
7. Do not block any ventilation openings. Install in accordance with the manufacturer's instructions.
8. Do not install near any heat sources such as radiators, heat registers, stoves, or other apparatus (including amplifiers) that produce heat.
9. Do not defeat the safety purpose of the polarized or grounding-type plug. A polarized plug has two blades with one wider than the other. A grounding-type plug has two blades and a third grounding prong. The wide blade or the third prong are provided for your safety. If the provided plug does not fit into your outlet, consult an electrician for replacement of the obsolete outlet.
10. Protect the power cord from being walked on or pinched particularly at plugs, convenience receptacles, and the point where they exit from the apparatus.
11. Only use attachments/accessories specified by the manufacturer.
12. Use only with the cart, stand, tripod, bracket, or table specified by the manufacturer, or sold with the apparatus. When a cart is used, use caution when moving the cart/apparatus combination to avoid injury from tip-over.
13. Unplug this apparatus during lightning storms or when unused for long periods of time.
14. Refer all servicing to qualified service personnel. Servicing is required when the apparatus has been damaged in any way, such as power-supply cord or plug is damaged, liquid has been spilled or objects have fallen into the apparatus, the apparatus has been exposed to rain or moisture, does not operate normally, or has been dropped.



Notes on the LCD panel of this display

- The Liquid Crystal Display (LCD) panel of this display has a very thin protective layer of glass which is liable to marking or scratching, and cracking if struck or pressured. The liquid crystal substrate is also liable to damage under excessive force or extreme temperatures. Please handle with care.
- The response time and brightness of the LCD panel may vary with the ambient temperature.
- Avoid placing the display in direct sun or where direct sun or spot lighting will shine onto the LCD panel, as the heat may damage the panel and the external casing of the display, and the bright light will make viewing the display more difficult than necessary.
- The LCD panel consists of individual pixels to display images and is manufactured according to the design specifications. While 99.9% of these pixels work normally, 0.01% of the pixels may remain constantly lit (in red, blue or green) or unlit. This is a technical limitation of the LCD technology and is not a defect.
- LCD screens, like plasma (PDP) and conventional CRT (Cathode Ray Tube) screens, are also susceptible to 'screen burn-in' or 'image retention' which can be found on the screen as visible fixed lines and shades. To avoid such damage to the screen, avoid displaying still images (like On-Screen Display menus, TV station logos, fixed/inactive text or icons) for more than two hours. Change the aspect ratio from time to time. Fill the entire screen with the image and eliminate the black bars whenever possible. Avoid displaying images in 4:3 aspect ratio over a long period of time, otherwise there may be visible burn marks on the screen as two vertical lines. If display of a still image is required, it is recommended to enable **Image Retention** under the **Setting and Advanced** menu.

Note:

- Under certain circumstances, condensation may occur on the inner side of the cover glass, it's a natural phenomenon and will not affect the operation of the display. This condensation will usually disappear after around 2 hours of normal operation.

Safety notice for remote control

- Do not put the remote control in the direct heat, humidity, and avoid fire.
- Do not drop the remote control.
- Do not expose the remote control to water or moisture. Failure to do so could result in malfunction.
- Confirm there is no object between the remote control and the remote sensor of the product.
- When the remote control will not be used for an extended period, remove the batteries.

Battery safety notice

The use of the wrong type of batteries may cause chemical leaks or explosion. Please note the following:

- Always ensure that the batteries are inserted with the positive and negative terminals in the correct direction as shown in the battery compartment.
- Different types of batteries have different characteristics. Do not mix different types.
- Do not mix old and new batteries. Mixing old and new batteries will shorten battery life or cause chemical leaks from the old batteries.
- When batteries fail to function, replace them immediately.
- Chemicals which leak from batteries may cause skin irritation. If any chemical matter seeps out of the batteries, wipe it up immediately using a dry cloth, and replace the batteries as soon as possible.
- Due to varying storage conditions, the battery life for the batteries included with your product may be shortened. Replace them within 3 months or as soon as you can after initial use.
- There may be local restrictions on the disposal or recycling of batteries. Consult your local regulations or waste disposal provider.

Package contents

Open the sales package and check the contents. If any item is missing or damaged, please contact your dealer immediately.



LCD display

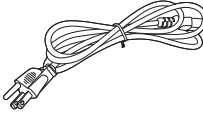

Power cord

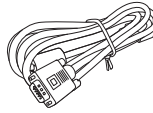

D-Sub (15-pin) cable

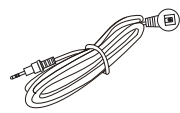

IR extender cable



Remote control

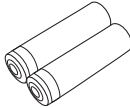

AAA batteries



Quick start guide

Notes:

- The type of power cord supplied may differ from that illustrated depending on your region of purchase.
- Before discarding the package, check that you haven't left any accessories inside the box.
- Dispose of packaging materials wisely. You can recycle the cardboard carton. Consider storing the package (if possible) for future transport of the display.
- Do not leave plastic bags within reach of young children or babies.

Setting up the display

Mounting the display

You can install the display on a vertical surface with a suitable wall mounting bracket or on a horizontal surface with a table stand. Please pay attention to the following notes during installation:

- This display should be installed by at least two adult persons. Attempting to install this display by only one person may result in danger and injuries.
- Refer the installation to qualified technicians. Improper installation may cause the display to fall or malfunction.

Installing the display on a wall

1. Place a clean, dry and lint-free cloth on a flat, horizontal and object-free surface. Make sure that the size of the cloth is larger than the display.
2. Gently lay the display on the cloth with the LCD screen facing down.
3. Identify the wall mounting screw holes on the back of the display as shown in the illustration.

Note:

- Screw type:
 - PS4652/PS5552: M6
 - PS6552: M8

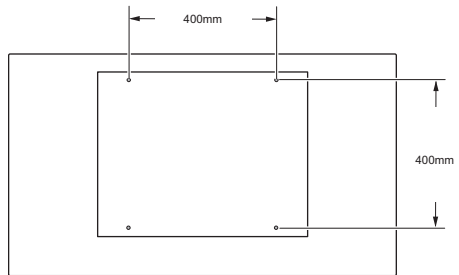

4. Install the wall mounting bracket on the wall according to the mounting bracket's instructions. The length of the screw should exceed the thickness of the wall mounting bracket by at least 10 mm. Make sure that all screws are tightened and secured properly. (Recommended torque: 470 - 635N·cm). The mounting means should be strong enough to bear the weight of the display.

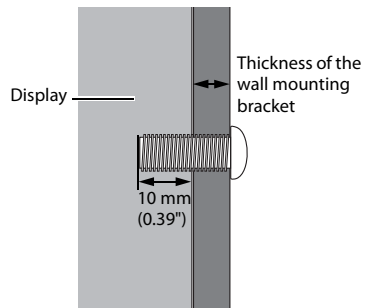

Note:

- To maintain proper ventilation, keep at least 10 mm of clear space from the back cover of the display to the wall.
- Please consult a professional technician for wall mount installations. The manufacturer accepts no liability for installations not performed by a professional technician.

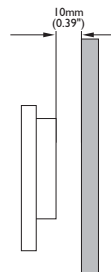

Parts of the display and their functions

Rear panel

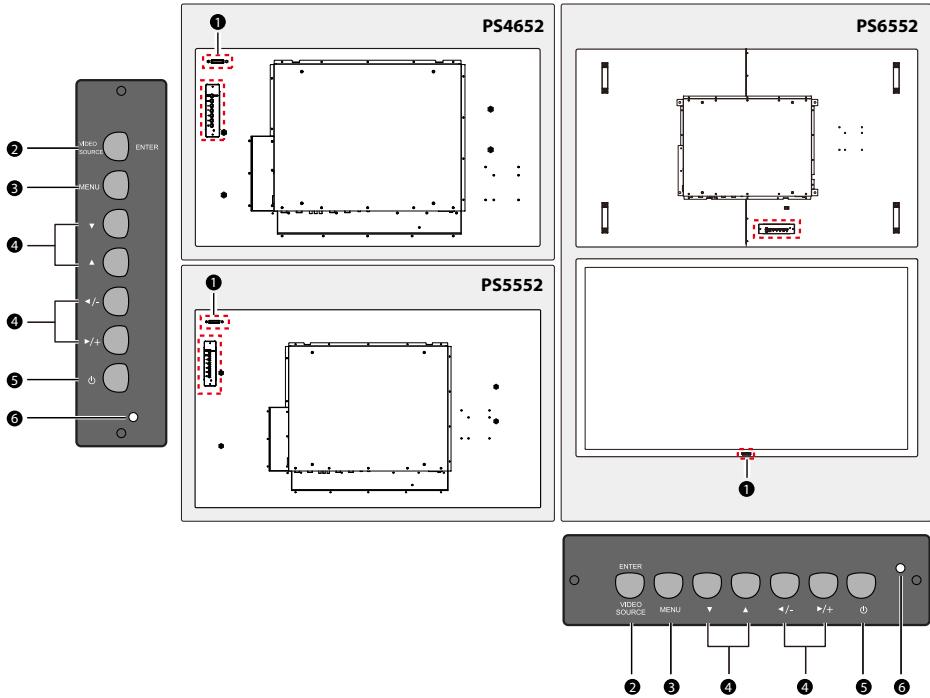

No.	Name	Description
1	Remote control sensor / Ambient light sensor / Power indicator	<ul style="list-style-type: none"> Receives command signals from the remote control. Detects ambient lighting conditions around the display and adjusts screen brightness automatically when the Ambient Light Sensor function is activated. Indicates the operating status of the display: <ul style="list-style-type: none"> Lights up green when searching for inputs. Lights up red when the display is turned off. Off when the main power is turned off.
2	ENTER/VIDEO SOURCE	<ul style="list-style-type: none"> Selects a video source. Confirms your selection or enters a submenu in the On-Screen Display (OSD) menu.
3	MENU	Opens or closes the OSD menu.
4	▼, ▲, ◀, /-, ▶, /+	<ul style="list-style-type: none"> Scrolls through settings and options in the OSD menu. ◀ /-, ▶ /+: Hot keys for audio volume adjustment.
5	Power button	Turns the display on or off.
6	Power indicator	<ul style="list-style-type: none"> Indicates the power status of the display: <ul style="list-style-type: none"> Lights up green when searching for inputs. Lights up red when the display is turned off. Off when the main power is turned off.

Input/output terminals

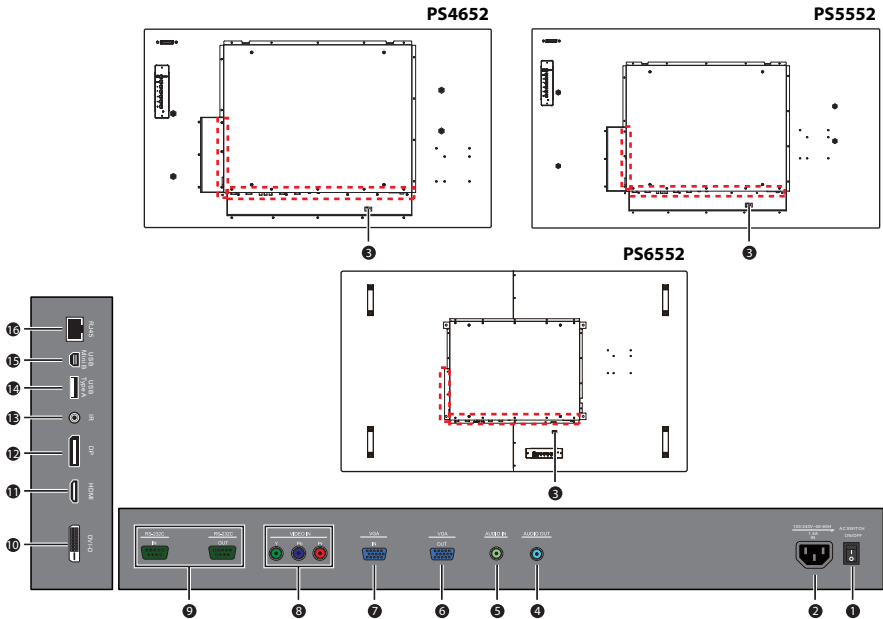

No.	Name	Description
1	AC SWITCH ON/OFF	Turns on or off the main power.
2	AC power input	Connects to a power outlet via the supplied power cord.
3	Power cable router clip	Assists in routing the power cable to avoid gravitational pull downward.
4	AUDIO OUT	Outputs audio signals to an external device. Audio is fixed.
5	AUDIO IN	Receives audio signals from an external device (such as a VCR, DVD player or a computer).
6	VGA OUT	Outputs analog RGB signals from the VGA IN input to another display.
7	VGA IN	Receives analog RGB signals from an external device (such as a computer).
8	VIDEO IN (YPbPr)	Receives component video (YPbPr) signals from an external device (such as a DVD player, HDTV device or Laser disc player).
9	RS232C IN/OUT	For external control and multi-display operation. <ul style="list-style-type: none"> • RS232C IN: receives control signals from a computer or another display. • RS232C OUT: outputs control signals from the RS232C IN input to another display.
10	DVI-D	Receives DVI signals from an external device (such as a computer).
11	HDMI	Receives HDMI signals from an external device (such as a Blu-ray disc player).
12	DP	Connects to a DisplayPort compatible device.
13	IR	For use with the supplied IR extender cable to ensure better signal reception from the remote control.

14	USB Type A	Connects to a USB flash drive.
15	USB Mini B	Connects to a computer for saving media content to internal memory.
16	RJ45	Connects to the RJ-45 port on your Ethernet or router.

Remote control

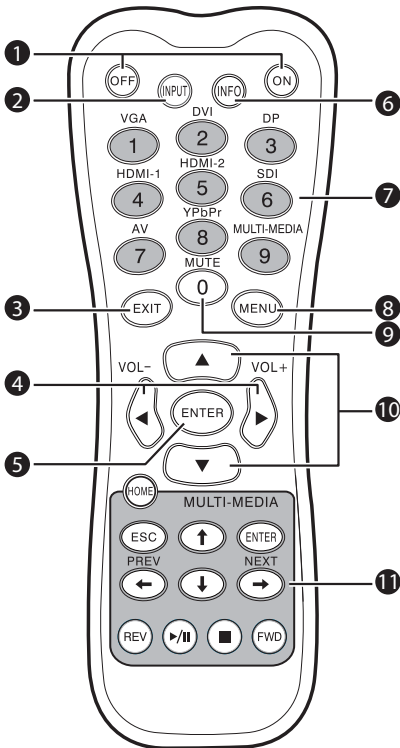

1 ON/OFF

Turns the display on or off.

2 INPUT

Selects an input source.

3 EXIT

Returns to a previous menu or closes the OSD menu.

4 ◀ / VOL- / ▶ / VOL+

- Scrolls through settings and options in the OSD menu.
- Turns down/up the volume.

5 ENTER

Confirms your selection or save changes.

6 INFO

Shows the current input source and resolution.

7 Numeric (1-9)/Input source buttons

- Performs as numeric buttons when the OSD menu is on.
- Performs as input source buttons when the OSD menu is off.

Note:

- The **HDMI-2**, **AV** and **SDI** functions are not available with this display.

8 MENU

Opens or closes the OSD menu.

9 Numeric button (0)/MUTE

- Performs as a numeric button when the OSD menu is on.
- Turns on or off the mute function.

10 ▲ / ▼

Scrolls through settings and options in the OSD menu.

11 MULTI-MEDIA buttons

See "Viewing multimedia contents" on page 40 for details.

Using the remote control

Installing remote control batteries

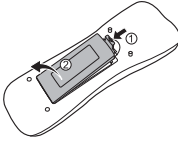

1. Open the remote control battery compartment cover.

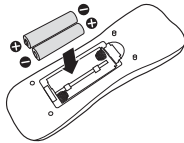

2. Insert the supplied batteries ensuring that the positive and negative marked battery terminals match the (+) and (-) marks in the battery compartment.

Note:

- The supplied batteries are provided for your convenience so that you can operate the display straight away. You should replace them as soon as possible.

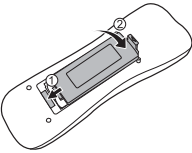

3. Refit the battery compartment cover.

Remote control usage tips

- Point and aim the top front of the remote control directly at the display's remote control sensor window or IR sensor on extender cable when pressing the buttons.
- Do not let the remote control become wet or place it in humid environments (like bathrooms).
- If the display's remote control sensor is exposed to direct sunlight or strong light, the remote control may not operate properly. In this situation, change the light source, readjust the angle of the display or operate the remote control from a location closer to display's remote control sensor.

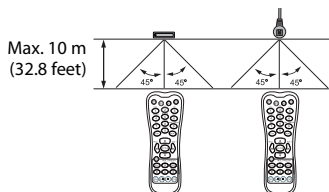
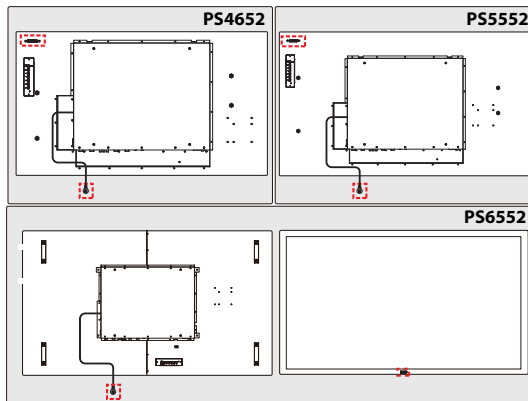

Connection

Connecting audio/video signals

Pay attention to the following notes when you connect cables:

- Please turn off all devices.
- Familiarize yourself with the audio/video ports on the display and the devices you want to use. Be aware that incorrect connections may adversely affect picture quality.
- Do not remove cables from the ports by pulling the cable itself. Always grasp and pull the connectors at the end of the cable.
- Ensure that all cables are fully inserted and firmly seated.

Connecting the VGA input

1. Connect the **VGA IN** jack on the display to the VGA output jack on a computer using the supplied D-Sub (15-pin) cable.
2. Connect the computer's audio output jack to the **AUDIO IN** jack on the display using a suitable audio cable. To select an appropriate audio source, see "Audio Source" on page 35 for details.
3. To view images from this input, press the **VGA** button on the remote control, or select **VGA** from the source selection bar.

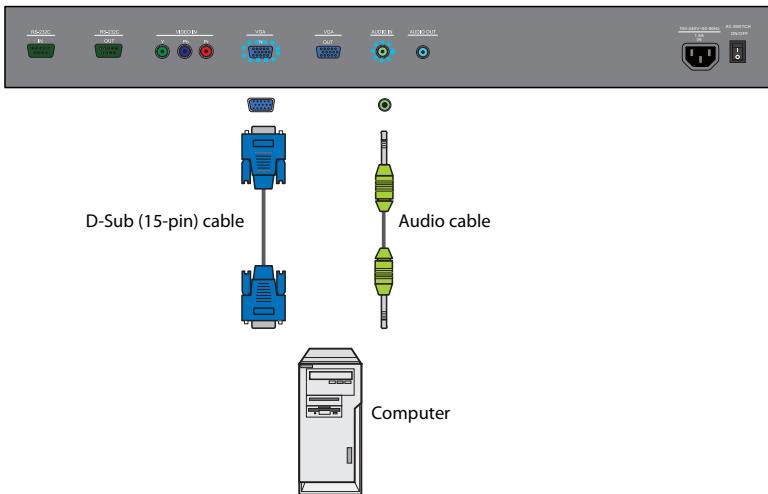

Note:

- The audio cable is not supplied and should be purchased separately.

Connecting the YPbPr component video input

1. Connect the **VIDEO IN (YPbPr)** jacks on the display to the component output jacks on an A/V device (such as a VCR or DVD player) using a component video cable.
2. Connect the A/V device's audio output jacks to the **AUDIO IN** jack on the display using a suitable audio cable. To select an appropriate audio source, see "Audio Source" on page 35 for details.
3. To view video image from this input, press the **YPbPr** button on the remote control, or select **YPbPr** from the source selection bar.

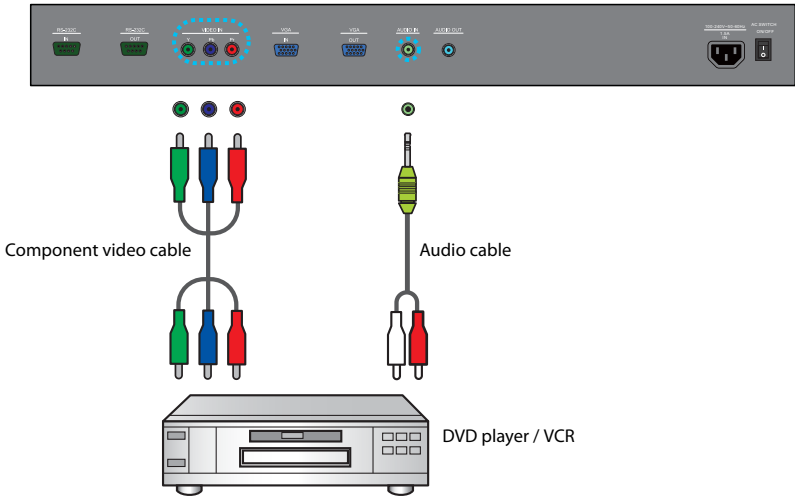

Note:

- The cables are not supplied and should be purchased separately.

Connecting the DVI-D digital input

1. Connect the **DVI-D** jack on the display to the DVI-D output jack on a computer using a DVI-D cable.
2. If needed, connect the computer's audio output jack to the **AUDIO IN** jack on the display using a suitable audio cable. To select an appropriate audio source, see "Audio Source" on page 35 for details.
3. To view video image from this input, press the **DVI** button on the remote control, or select **DVI** from the source selection bar.

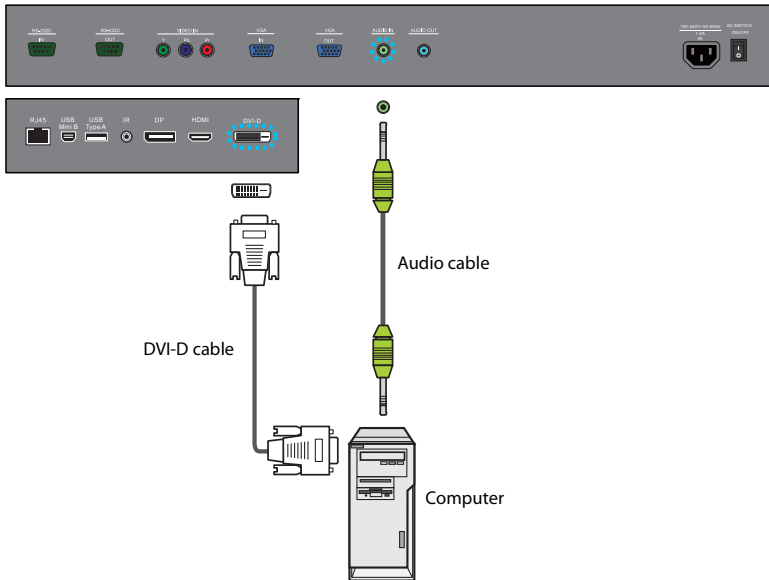

Note:

- The cables are not supplied and should be purchased separately.

Connecting the HDMI digital input

1. Connect the **HDMI** jack on the display to the HDMI output jack on a computer using an HDMI cable or a DVI-D to HDMI conversion cable.
2. If needed, connect the computer's audio output jack to the **AUDIO IN** jack on the display using a suitable audio cable. To select an appropriate audio source, see "Audio Source" on page 35 for details.
3. To view video image from this input, press the **HDMI-1** button on the remote control, or select **HDMI** from the source selection bar.

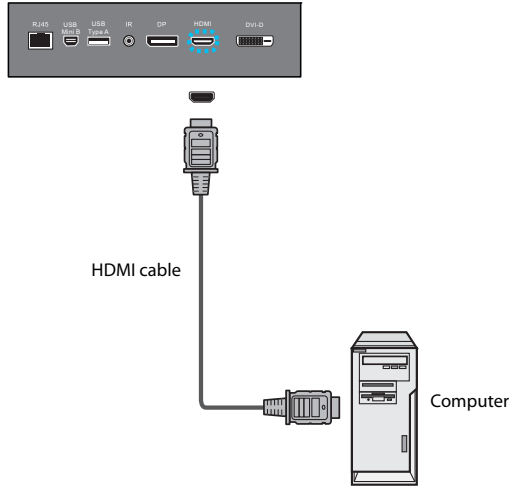

Note:

- The cables are not supplied and should be purchased separately.

Connecting the DisplayPort (DP) digital input

1. Connect the **DP** jack on the display to the DisplayPort output jack on a computer using a DisplayPort cable.
2. To view video image from this input, press the **DP** button on the remote control, or select **DisplayPort** from the source selection bar.

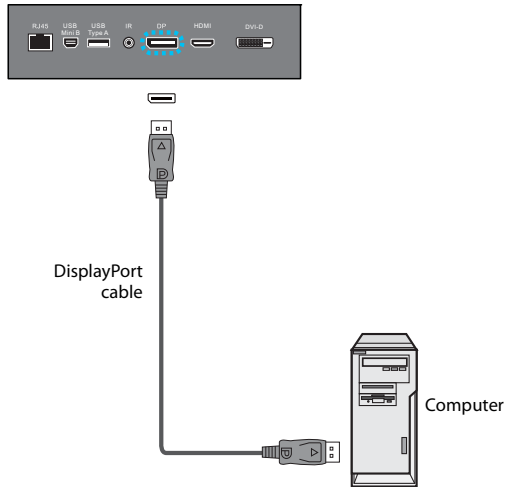

Note:

- The cables are not supplied and should be purchased separately.

Connecting multiple displays

You can connect multiple displays serially (daisy chain connection) to a computer for management. The number of displays you can connect serially depends on the resolution of the input signal you use.

The first display

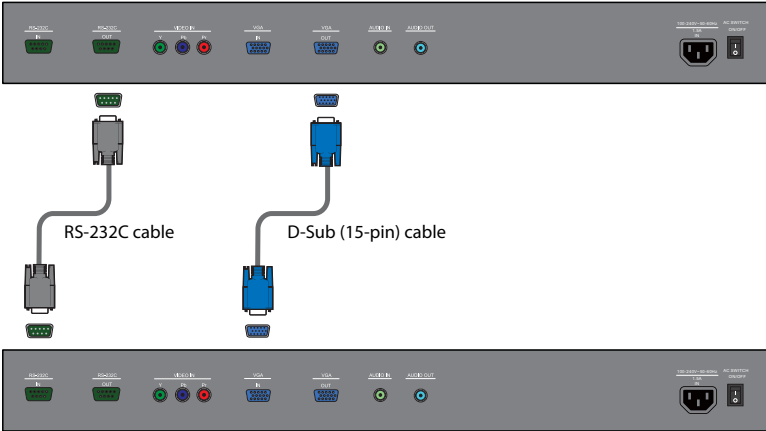

Additional display

Notes:

- This RS-232C daisy chain connection requires an RS-232C port equipped computer.
- Use RS-232C serial null modem cables for daisy chain connection.
- Avoid using HDCP source for daisy chain connection.

Connecting power

1. Plug one end of the power cord into the AC power input jack on the display and the other end into an appropriate power outlet (if the outlet is switched, turn on the switch).
2. Flick the **AC SWITCH ON/OFF** switch to the ON position to turn on the main power.

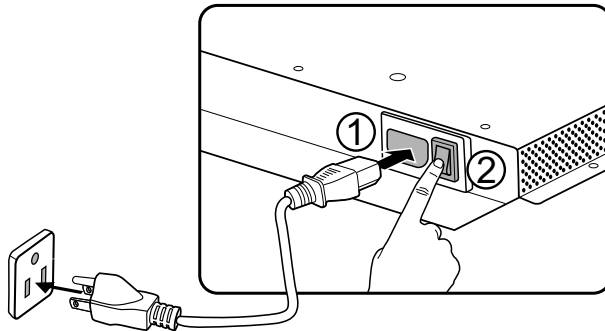

Notes:

- The supplied power cord is suitable for use with 100-240V AC power only.
- The power cord and outlet illustrated may differ from the ones used in your region.
- Only use an appropriate power cord for your region. Never use a power cord which appears damaged or frayed, or change the plug type on the power cord.
- Be aware of the power loading when you use extension cords or multiple outlet power boards.
- There are no user serviceable parts in this display. Never unscrew or remove any covers. There are dangerous voltages inside the display. Turn off the power and unplug the power cord if you intend to move the display.

Basic operations

Turning the display on or off

To turn on or off the display, press the Power button on the display's control panel or on the remote control.



Notes:

- The display's standby mode still consumes power. To completely cut off power supply, set the power switch to the off position or disconnect the power cord from the power outlet.
- The display follows the VESA approved DPM Power Management function. The power management function is an energy saving feature that automatically reduces the display's power consumption when the keyboard or the mouse has not been used for a fixed period.



Locking/unlocking the controls

You can lock/unlock the control panel to prevent unwanted or accidental operations.

Control panel buttons

To lock/unlock the control panel buttons, press and hold the ◀ /- and ▶ /+ buttons on the control panel simultaneously for at least 5 seconds. Once locked, the control panel buttons do not function unless unlocked.

Remote control functions

To lock/unlock the remote control functions, press and hold the **MENU** and ◀ /- buttons on the control panel for at least 5 seconds. Once locked, the display does not respond to any remote control operations unless unlocked.

To lock/unlock both the control panel and remote control buttons, press the ▼ button for at least 5 seconds, and then the **ENTER** button on the remote control. Once locked, the control panel and remote control buttons do not function unless unlocked.

Switching input signals

Press the **INPUT** button or those signal selection buttons on the remote control or the **INPUT** button on the control panel to select an input signal.

Adjusting audio volume level

Press the ◀ /- or ▶ /+ button on the control panel, or the **VOL+** or **VOL-** button on the remote control to adjust the volume.

Network connection

Connecting the display to a local area network

To set the display to connect to a local area network (LAN):

1. Connect a RJ45 cable to the corresponding ports on the display and your LAN switch or router.
2. Open the OSD menu. Go to **Setting > Control Setting** and select **LAN**.
3. Go to **Setting > Network Settings** and perform either of the following settings according to your network environment. You may need to contact your network administrator for assistance on these settings.
 - If you are in a DHCP environment (the IP address of the display will be automatically assigned by a DHCP server), select **DHCP > Execute** and press the **ENTER** button on the remote control. Once the display is successfully connected, the **IP Address, Subnet Mask, Default Gateway, Primary DNS, and Secondary DNS** information will be displayed.
 - If you are not in a DHCP environment (the IP address of the display has to be configured manually), select **Manual > Execute** and press the **ENTER** button on the remote control. Contact your network administrator for information on the **IP Address, Subnet Mask, Default Gateway, Primary DNS, and Secondary DNS** settings and enter them accordingly.
4. To save the settings and return to the previous menu, highlight **Execute** and press the **ENTER** button on the remote control.

Remote network control

Once the display is connected via LAN connection, you can access the display's built-in remote network control interface using a computer and the display's IP address.

Notes:

- The computer and display must have the same **Subnet Mask, Default Gateway, Primary DNS and Secondary DNS** settings.
- You cannot control the display via the RS-232C connection when LAN control is in use. However, you can set the TCP port number of the LAN connection to 4660 if you want to control the display using RS-232 protocol. See "RS232 commands over the network" on page 30.
- The recommended Internet browser is Internet Explorer version 7.0 or higher.
 1. Enter the IP address of the display in the address bar of the Internet browser and press **Enter**.
 2. The remote network control interface appears.

Information

The **Information** page provides general information about the display.

Network Control		1.01Rev7
INFORMATION	PICTURE&SOUND	SCREEN
SETTING	SCHEDULE	MAIL REPORT
NETWORK		
Information		
Display		
Model Name:	PS5552	
Serial Number:	SGDMYXXXXPP0	
Status		
Power Status:	Power On	
Video Source:	HDMI	
PAP Enable:	Off	
Network		
IP Address:	10.82.26.111	
Subnet Mask:	255.255.255.0	
Gateway:	10.82.26.254	
Primary DNS:	10.82.15.15	
Secondary DNS:	10.82.15.17	
MAC Address:	08.00.27.47.D5.43	
Other Information		
Scaler FW Version:	0.31	
Lan FW Version:	1.01Rev7	
Operation Time:	0000008H	

Picture & Sound

The Picture & Sound page provides options for picture and sound adjustments. For more information about how to adjust these settings, please refer to "Picture menu" on page 34 and "Sound menu" on page 35.

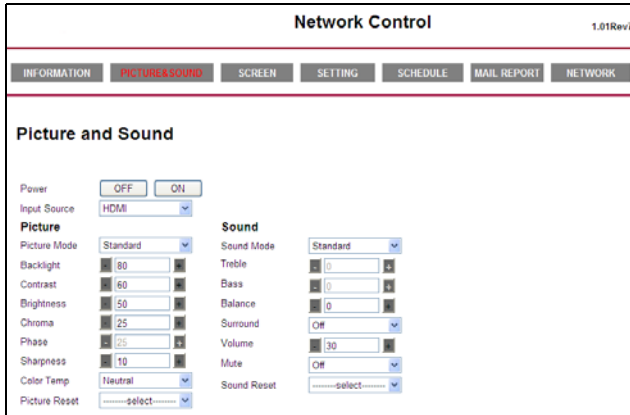

Note:

- The Power ON and OFF buttons will be disabled (grayed out) when the input source is **Multi-Media**.
- Make sure the **Setting > Control Setting** menu is set to **LAN**, and the **Setting > Power Save** menu is set to **Standard** or **Off** if you would like to turn on the display from a web page. If the **Setting > Power Save** menu is set to **ECO**, the Power ON button will be disabled (grayed out).

Screen

The Screen page provides options related to display adjustments. For more information about how to adjust these settings, please refer to "Screen menu" on page 36.

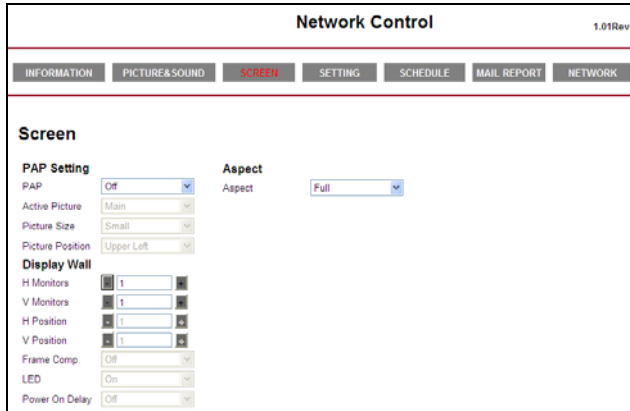

Setting

The **Setting** page provides options for advanced display adjustments. For more information about how to adjust these settings, please refer to "Setting menu" on page 38.

Network Control 1.01Rev7

INFORMATION
PICTURE&SOUND
SCREEN
SETTING
SCHEDULE
MAIL REPORT
NETWORK

Setting

Setting

Monitor ID (1-99)

Power Save

Auto Search

Ambient Light Sensor

Schedule

The **Schedule** page provides options for configuring current time and date, and up to 7 schedule settings for the display to turn on and off automatically. For more information about how to set up schedules, please refer to "Schedule" on page 38.

Network Control 1.01Rev7

INFORMATION
PICTURE&SOUND
SCREEN
SETTING
SCHEDULE
MAIL REPORT
NETWORK

Year / Month / Day Time

Timer

	On Time	Off Time	Input
<input type="checkbox"/> No1	<input type="text" value=""/> <input type="text" value=""/> <input type="text" value=""/>	<input type="text" value=""/> <input type="text" value=""/> <input type="text" value=""/>	Default <input type="button" value="Apply"/>
	<input type="checkbox"/> Sun <input type="checkbox"/> Mon <input type="checkbox"/> Tue <input type="checkbox"/> Wed <input type="checkbox"/> Thu <input type="checkbox"/> Fri <input type="checkbox"/> Sat	<input type="checkbox"/> Everyday	
<input type="checkbox"/> No2	<input type="text" value=""/> <input type="text" value=""/> <input type="text" value=""/>	<input type="text" value=""/> <input type="text" value=""/> <input type="text" value=""/>	Default <input type="button" value="Apply"/>
	<input type="checkbox"/> Sun <input type="checkbox"/> Mon <input type="checkbox"/> Tue <input type="checkbox"/> Wed <input type="checkbox"/> Thu <input type="checkbox"/> Fri <input type="checkbox"/> Sat	<input type="checkbox"/> Everyday	
<input type="checkbox"/> No3	<input type="text" value=""/> <input type="text" value=""/> <input type="text" value=""/>	<input type="text" value=""/> <input type="text" value=""/> <input type="text" value=""/>	Default <input type="button" value="Apply"/>
	<input type="checkbox"/> Sun <input type="checkbox"/> Mon <input type="checkbox"/> Tue <input type="checkbox"/> Wed <input type="checkbox"/> Thu <input type="checkbox"/> Fri <input type="checkbox"/> Sat	<input type="checkbox"/> Everyday	
<input type="checkbox"/> No4	<input type="text" value=""/> <input type="text" value=""/> <input type="text" value=""/>	<input type="text" value=""/> <input type="text" value=""/> <input type="text" value=""/>	Default <input type="button" value="Apply"/>
	<input type="checkbox"/> Sun <input type="checkbox"/> Mon <input type="checkbox"/> Tue <input type="checkbox"/> Wed <input type="checkbox"/> Thu <input type="checkbox"/> Fri <input type="checkbox"/> Sat	<input type="checkbox"/> Everyday	
<input type="checkbox"/> No5	<input type="text" value=""/> <input type="text" value=""/> <input type="text" value=""/>	<input type="text" value=""/> <input type="text" value=""/> <input type="text" value=""/>	Default <input type="button" value="Apply"/>
	<input type="checkbox"/> Sun <input type="checkbox"/> Mon <input type="checkbox"/> Tue <input type="checkbox"/> Wed <input type="checkbox"/> Thu <input type="checkbox"/> Fri <input type="checkbox"/> Sat	<input type="checkbox"/> Everyday	
<input type="checkbox"/> No6	<input type="text" value=""/> <input type="text" value=""/> <input type="text" value=""/>	<input type="text" value=""/> <input type="text" value=""/> <input type="text" value=""/>	Default <input type="button" value="Apply"/>
	<input type="checkbox"/> Sun <input type="checkbox"/> Mon <input type="checkbox"/> Tue <input type="checkbox"/> Wed <input type="checkbox"/> Thu <input type="checkbox"/> Fri <input type="checkbox"/> Sat	<input type="checkbox"/> Everyday	
<input type="checkbox"/> No7	<input type="text" value=""/> <input type="text" value=""/> <input type="text" value=""/>	<input type="text" value=""/> <input type="text" value=""/> <input type="text" value=""/>	Default <input type="button" value="Apply"/>
	<input type="checkbox"/> Sun <input type="checkbox"/> Mon <input type="checkbox"/> Tue <input type="checkbox"/> Wed <input type="checkbox"/> Thu <input type="checkbox"/> Fri <input type="checkbox"/> Sat	<input type="checkbox"/> Everyday	

Mail Report

The **Mail Report** page provides options for configuring email server settings for sending status or alert reports from the display.

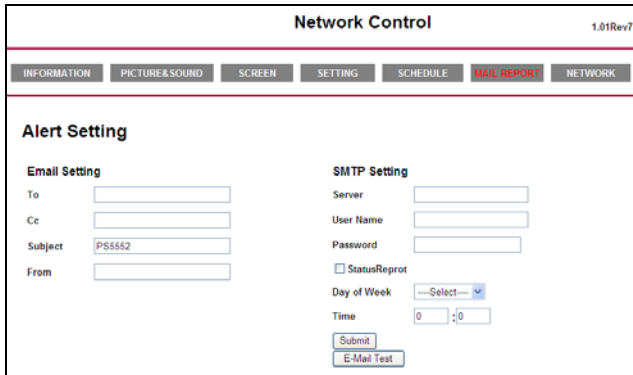

The screenshot shows a web interface titled "Network Control" with a version number "1.01Rev7" in the top right corner. Below the title is a navigation bar with tabs for "INFORMATION", "PICTURE&SOUND", "SCREEN", "SETTING", "SCHEDULE", "MAIL REPORT", and "NETWORK". The "MAIL REPORT" tab is selected. The main content area is titled "Alert Setting" and is divided into two columns: "Email Setting" and "SMTP Setting".

Email Setting

- To:
- Cc:
- Subject:
- From:

SMTP Setting

- Server:
- User Name:
- Password:
- StatusReport
- Day of Week:
- Time: :

Buttons: and

Configuring mail server settings

The mail server settings must be correctly configured for the display to send email messages.

1. Specify the recipient's and sender's email addresses and email subject under Email Setting.
2. Obtain the server address, user name and password information from your email server administrator and enter them in the corresponding fields under SMTP Setting.
3. If you want the display to send a status report periodically, check the Status Report checkbox and specify the time and day of the week when the report will be sent.
4. Click the **Submit** button to complete setup. You can also click the **E-Mail Test** button to set the display to send a test email for verification.

Status report

If activated, a status report will be generated and sent periodically according to your settings in the **Mail Report** page. Below is an example of the format and content of the status report.

```
Status Report

[Display]
Model Name: (Model name of the display)
Serial No.: (Serial number of the display)

[STATUS]
Power Status: Power On
Video Source: HDMI
PAP Enable: Off

[Network]
IP Address: xx.xx.xx.xx
Subnet Mask: xx.xx.xx.xx
Gateway: xx.xx.xx.xx
Primary DNS: xx.xx.xx.xx
Secondary DNS: xx.xx.xx.xx
MAC Address: xx:xx:xx:xx:xx:xx

[Other Information]
Scaler F/W Version: x.x
Lan F/W Version: x.xx Revx
Operation: 0000008H
```

Alert report - thermal error

If the display's ambient temperature exceeds 50°C (122°F) for over 30 seconds, a thermal error alert report will be generated and sent to the specified recipient. Below is an example of the format and content of the report.

```
Thermal Error

[Display]
Model Name: (Model name of the display)
Serial No.: (Serial number of the display)

[STATUS]
Power Status: Power On
Video Source: HDMI
PAP Enable: Off

[Network]
IP Address: xx.xx.xx.xx
Subnet Mask: xx.xx.xx.xx
Gateway: xx.xx.xx.xx
Primary DNS: xx.xx.xx.xx
Secondary DNS: xx.xx.xx.xx
MAC Address: xx:xx:xx:xx:xx:xx

[Other Information]
Scaler F/W Version: x.x
Lan F/W Version: x.xx Revx
Operation: 0000008H
```

If a thermal error alert occurs, turn off the display and check if the space or passage around the display for heat dissipation is blocked. Improve ventilation and air circulation around the display if necessary.

Alert report - voltage error

If a fluctuation in DC power supply to the display's internal components (scaler IC and backlight) occurs, a voltage error alert report will be generated and sent to the specified recipient, and the display will turn off automatically. Below is an example of the format and content of the report.

Voltage Error

[Display]

Model Name: (Model name of the display)

Serial No.: (Serial number of the display)

[STATUS]

Power Status: Power On

Video Source: HDMI

PAP Enable: Off

[Network]

IP Address: xx.xx.xx.xx

Subnet Mask: xx.xx.xx.xx

Gateway: xx.xx.xx.xx

Primary DNS: xx.xx.xx.xx

Secondary DNS: xx.xx.xx.xx

MAC Address: xx:xx:xx:xx:xx:xx

[Other Information]

Scaler F/W Version: x.x

Lan F/W Version: x.xx Rev x

Operation: 0000008H

If a voltage error alert occurs, consider the following measures:

- Check if there are any loose connections between power cables and sockets.
- Make sure that the power supply is not accidentally turned off (if the power supply device/outlet has a switch)

Network

Provides options for manually setting the display's IP address or obtaining an IP address automatically from a DHCP server. For more information about how to configure network settings, please refer to "Connecting the display to a local area network" on page 21.

Network Control 1.01Rev7

INFORMATION PICTURE&SOUND SCREEN SETTING SCHEDULE MAIL REPORT **NETWORK**

Network Setting

Network

DHCP Manual

IP Address

Subnet Mask

Gateway

Primary DNS

Secondary DNS

RS232 commands over the network

The PS-Series also supports extending access to the RS232 commands over a network connection. Below are the steps to follow for controlling the display over LAN through the RJ45 connector.

1. Connect display & PC to hub or connect display to PC with LAN cable directly.
2. Set display IP address. (See "Connecting the display to a local area network" on page 21)
3. Commands are sent via TCP connection to port 4660. The commands are the same as for the RS232 port (see PS-Series RS232 manual on www.planar.com).
4. You can test commands using any TCP utility program that allows you to enter binary data in hexadecimal format. (Note: Contact Planar Technical Support for recommended programs.)

The OSD (On-Screen Display) menu

OSD menu overview



Menu item	Function	Category	See page	
Picture	Picture Mode	C	34	
	Backlight	D		
	Contrast			
	Brightness			
	Color			
	Sharpness			
	Color Temp.			
	Noise Reduction	B		
	Film Mode	E		
Reset				
Sound	Sound Mode	E	35	
	Treble			
	Bass			
	Balance			
	Surround			
	Speaker			
	Audio Source	B		
Reset	E			
Screen	PAP Setting	E	36	
	Display Wall	C		
	Aspect			
	Adjust Screen	A		
	Freeze	E		
Setting	Language	E	38	
	Schedule			
	Power Save			
	Control Setting			
	Network Settings			
	Set Monitor ID			
	HDMI Control			
	Advanced	Auto Search		E
		Auto Adjustment		B
		Overscan		
		RGB Signal		E
		Image Retention		
		OSD Rotation		
		OSD Info Box		
		Adaptive Contrast		
Ambient Light Sensor				
Information	E			
All Reset				

Notes:

- Category A functions are only available when the signal is input from **VGA IN**.
- Category B functions allow for different settings for each input signal source.

- Category C functions allow for different settings for each input signal source and signal type (PC or video).
- Category D functions allow for different settings for each input signal source, signal type (PC or video) and Picture Mode.
- Settings of category E functions affect globally over all input signal sources, signal types and Picture Modes.

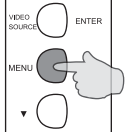
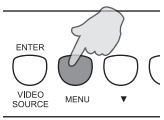
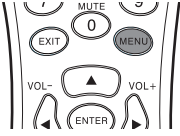
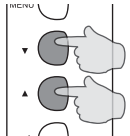
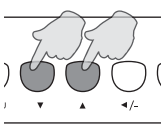
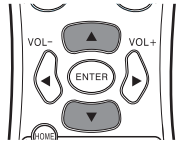
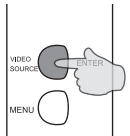
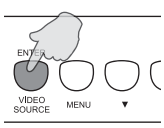
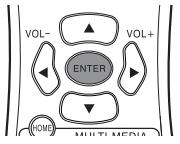
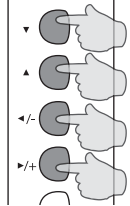
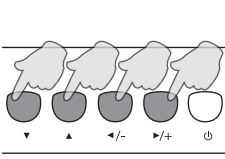
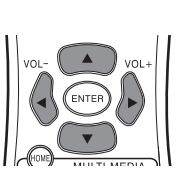
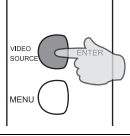
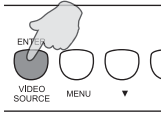
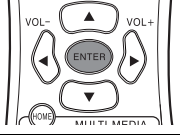
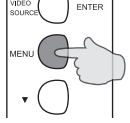
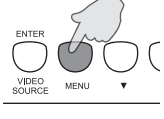
Operations in the OSD menu

Operation	Using the control panel		Using the remote control
	PS4652/PS5552	PS6552	
1. Press MENU to open the OSD menu.			
2. In the OSD menu, press ▲ or ▼ to select an item.			
3. Press ENTER/VIDEO SOURCE (or ENTER) to confirm selection.			
4. Press ▲ or ▼ to select a feature and press ◀ or ▶ to adjust settings.			
5. Press ENTER/VIDEO SOURCE (or ENTER) to save changes.			
6. Press MENU to close the OSD menu.			

Picture menu

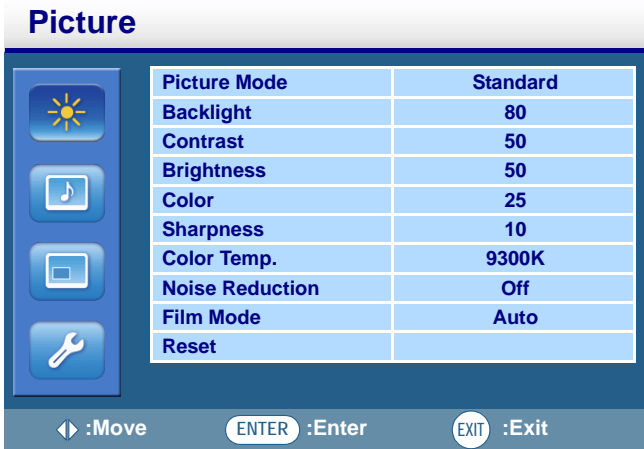

Item	Description
Picture Mode	Provides preset picture modes (Vivid , Standard and Cinema) for using the display in different environments, and one customizable picture mode (Custom) for setting up a user preferred mode.
Backlight	Adjusts the backlight intensity for the screen. Note: • This feature is not available if the Ambient Light Sensor or Adaptive Contrast function is set to On .
Contrast	Adjusts the contrast of the image.
Brightness	Adjusts the brightness of the image.
Color	Adjusts the color intensity of the image.
Sharpness	Adjusts the image sharpness.
Color Temp.	Adjusts the color temperature.
Noise Reduction	Reduces electrical image noise caused by different media players.
Film Mode	Optimizes the screen display automatically by detecting picture content and applying a reverse 3-2 or 2-2 pull-down process. The picture will be clearer and more natural. Notes: • This function is available only with MultiMedia and YPbPr inputs. • This function may not be correctly processed depending on the input signal.
Reset	Resets all settings in the Picture menu.

Sound menu



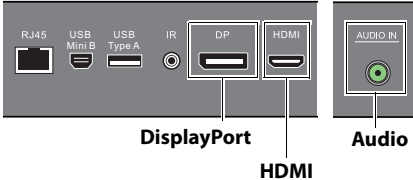

Item	Description
Sound Mode	Adjusts the sound output from the speakers. <ul style="list-style-type: none"> • Dynamic: Enhances treble and bass. • Standard: Flat settings. • Custom: Recalls the customized settings.
Treble	Adjusts the audio treble when Sound Mode is set to Custom .
Bass	Adjusts the audio bass when Sound Mode is set to Custom .
Balance	Adjusts the audio balance when Sound Mode is set to Custom .
Surround	Turns the surround mode on or off.
Speaker	Sets the audio source. <ul style="list-style-type: none"> • Line-Out: Selects the audio output source from AUDIO OUT on the rear connector panel. • Internal: Selects the audio output source from the internal speakers.
Audio Source	Sets the audio input source.  <ul style="list-style-type: none"> • Multi-Media: The audio source is from the multi-media contents via the USB ports.
Reset	Resets all settings in the Sound menu.

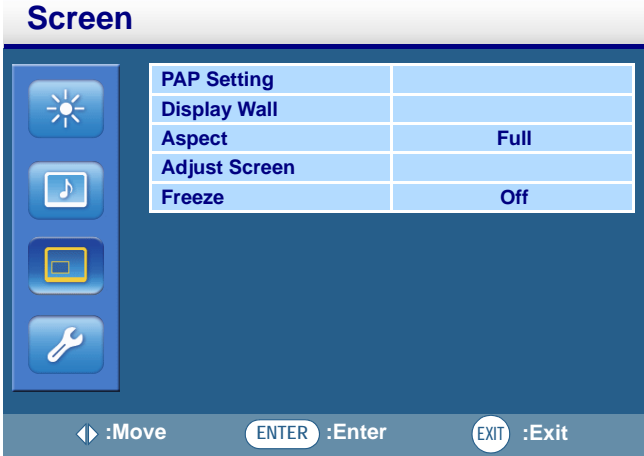
Screen menu

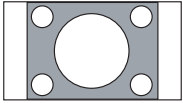
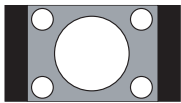
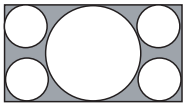
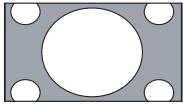
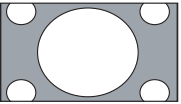
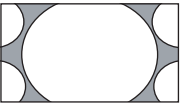
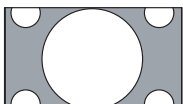
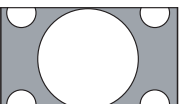

Item	Description
PAP Setting (Picture and Picture)	<ul style="list-style-type: none"> • PAP: Turns on or off the PIP (Picture in Picture) and PBP (Picture by Picture) functions. • Active Picture: For the PIP, selects the main or sub picture to operate. For the PBP, selects the left or right picture to operate. Swaps the main/ sub or left/right pictures. • Picture Size: Changes the size of the sub picture. • Picture Position: (PIP only) Changes the position of the sub picture. <p>Notes:</p> <ul style="list-style-type: none"> • PAP is not available for all signal source combinations. See "Supported PAP input signal combination" on page 61 for more information on supported combinations. • In PAP mode, only sound from the active picture will be available.
Display Wall	<ul style="list-style-type: none"> • H. Monitors/V. Monitors: Sets the number of displays used in the horizontal/ vertical direction. • H. Position/V. Position: Sets the horizontal/vertical position of the display wall matrix. • Frame Comp.: Adjusts images near the display edges for optimal demonstration across the display wall. • LED: Turns the power indicator on the display on or off. • Power On Delay: Choose to enable or disable a sequence in turning on the screen matrix. If enabled, the display will turn on with a maximum of 10-second delay.
Aspect	Sets the picture's aspect ratio. <ul style="list-style-type: none"> • Wide Zoom: Enlarges to fill screen with minimum distortion. • Zoom: Enlarges the picture, keeping the same aspect ratio.

- **Full:** Enlarges the picture horizontally to fill the screen when the picture source is 4:3 (Standard definition). When the picture source is 16:9 (High definition), it displays in the same 16:9 aspect ratio.
- **4:3:** Displays all picture source in 4:3 aspect ratio.
- **Original:** Enlarges the picture to fill the screen in the vertical direction, keeping the same aspect ratio. A black frame may appear around the picture.
- **Full:** Enlarges the picture to fill the screen.
- **Native:** Displays the picture in its original number of dots.

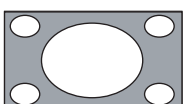
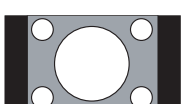
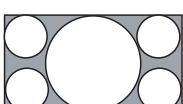
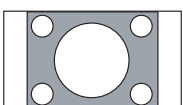
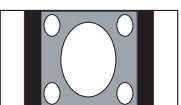
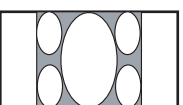
For video signal inputs		
4:3 original source	16:9 Original source	
		
Wide Zoom 	Wide Zoom 	
Zoom 	Zoom 	
Full 	Full 	
4:3 	4:3 	

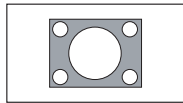
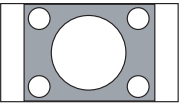
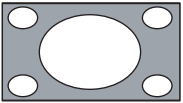
For PC signal input		
Native	Original	Full
		

Aspect
(continued)

Adjust Screen

- **Auto Adjustment:** Sets whether to optimize image display for **VGA** input.
- **Phase:** Adjusts the phase of the **VGA** input image.
- **Clock Frequency:** Adjusts the clock frequency of the **VGA** input image.
- **H. Position:** Adjusts the horizontal position of the **VGA** input image.
- **V. Position:** Adjusts the vertical position of the **VGA** input image.

Freeze

Freezes the displayed image.

Setting menu

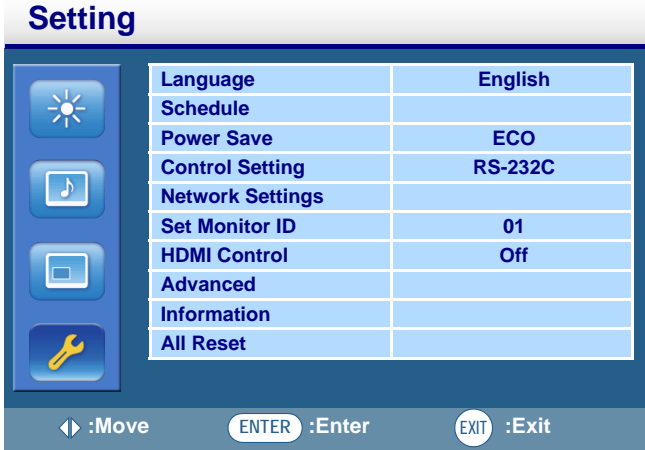

Item	Description
Language	Sets your preferred language for the OSD menu.
Schedule	<ul style="list-style-type: none"> • Date and Time: Sets the current date and time. • Clock Display: Sets whether to show the current time which was set. • Input: Sets an input source to display when the display is automatically turned on next time. • On/Off Timer: Sets when to turn on or off the display. <p>Notes:</p> <ul style="list-style-type: none"> • Set the current time before you set the On/Off Timer. • When schedule settings overlap, the Everyday setting takes priority over other weekly settings.
Power Save	<p>Sets the display to enter the power saving mode when there is no signal detected.</p> <ul style="list-style-type: none"> • Standard: All sources can enter the power saving mode and wake up the display. • ECO: All sources can enter the power saving mode, but only a VGA signal can wake up the display or you have to press the power button to wake up the display when other sources are connected. • Off: If no source is detected, the backlight will continue on. <p>Note:</p> <ul style="list-style-type: none"> • RS-232C can bring any mode out of the power saving status. • On Power Save setting ECO, the LAN function is not available if the monitor enters Power Save, or DC off mode.
Control Setting	<ul style="list-style-type: none"> • RS-232C/LAN: Sets a terminal to control the display. • IR: Select it when multiple displays are connected via RS-232C cables. <ul style="list-style-type: none"> - Primary: Designate the display as the primary unit for remote control operation. Only this display will be operated by the remote control. - Secondary: Designate the display as the secondary unit. The display can not be operated by the remote control, and will only receive the control signal from the primary display via the RS-232 connection. <p>Note:</p> <ul style="list-style-type: none"> • To reset to the default settings (RS-232C) for Control Setting, press the INFO button on the remote control for 5 seconds. • The power of the secondary display can not be turned on by the control signal received from the primary display.
Network Settings	See "Network connection" on page 21 for details.

Set Monitor ID	<p>Assigns an ID number for the current display when multiple displays are connected.</p> <p>Note:</p> <ul style="list-style-type: none"> • For use under the RS-232C control mode.
HDMI Control	<p>Uses the HDMI CEC (Consumer Electronics Control) industry standard protocol to share functionality between connected devices and the display. To transfer system commands, you need to use an HDMI cable to connect the display to a device equipped with HDMI CEC. Select On in this menu and you can operate the main functionalities on your display and the connected device with one remote control.</p>
Advanced	<ul style="list-style-type: none"> • Auto Search: Automatically detects available input sources. • Auto Adjustment: Automatically optimizes image display for the VGA input. • Overscan: Turns the overscan function on or off. • RGB Signal: Sets the type of signal for a piece of video equipment or PC connected to the HDMI of the display. <ul style="list-style-type: none"> - If the color space of the input signal is YCbCr, the input range will be fixed as 16~235 regardless of your selection of PC or Video. - If the color space of the input signal is RGB, the input range will be set to 0~255 if you select PC, and 16~235 if you select Video. <p>Note:</p> <ul style="list-style-type: none"> • This function is only available when the input source is HDMI at the following resolutions: <ul style="list-style-type: none"> - 480p60 (640x480@60) - 576p50 - 720p50/60 (1280x720@60) - 1080p50/60 (1920x1080@60) • Image Retention: Automatically displays swift moving patterns to prevent image retention on the screen. • OSD Rotation: Changes the OSD orientation. <p>Note:</p> <ul style="list-style-type: none"> • See product specifications for models recommended for portrait orientation. Landscape only models operated in portrait mode may result in premature failure and will not be covered under the warranty.
Advanced	<ul style="list-style-type: none"> • OSD Info Box: When turned On, switching signal inputs, or changing timing, the display will show the current input source and resolution onscreen. Select Off to show the information box onscreen only when you press INFO on the remote control. • Adaptive Contrast: Turns the Adaptive Contrast function on or off. This feature enhances image contrast for dark scenes. <p>Note:</p> <ul style="list-style-type: none"> • This feature is not available if the Ambient Light Sensor function is set to On. • Ambient Light Sensor: When turned On, the image brightness will change automatically as the ambient lighting conditions change.
Information	<p>Displays the following information of your display.</p> <ul style="list-style-type: none"> • Date • Model Name • Serial Number • Operating Time • Software Version • LAN Version • IP Address
All Reset	<p>Returns all settings to factory default values.</p>

Viewing multimedia contents

You can play audio, video and view document files on a USB device or in the display's built-in memory using the multimedia menu.

To change to multimedia input:

1. Make sure the display is correctly connected to an external device.
2. Press the **MULTI-MEDIA** button on the remote control or select **MULTI-MEDIA** from the source selection bar. The multimedia menu appears.



Multimedia control buttons on the remote control



You can use the multimedia control buttons on the remote control to navigate the multimedia menu and control the playback functions.

No	Name	Description
1	HOME	Goes back to the main page.
2	ESC	Goes back to the previous page.
3	ENTER	Activates the selected menu item.
4	←/↑/↓/→ (PREV) (NEXT)	Directional arrows for selecting a desired item.
5	REV	Rewinds the video/audio.
6	▶/	Plays/pauses the video/audio.
7	■	Stops playing the video/audio.
8	FWD	Fast forwards the video/audio.

Viewing files

Viewing files in the display's built-in memory

The display is equipped with a 4GB built-in memory. You can transfer files from a computer to the built-in memory and view these files on the display.

1. On the display, enable the **USBConnect** function in the **Settings > System > USBConnect** menu.
2. Connect the **USB Mini B** jack on the display to the USB port of the computer using a USB cable.
3. Once connected, locate the Removable Disk on your computer. Select and drag the files from your computer to the Removable Disk.
4. On the display, go to the **EZ Media > Internal** menu to view the files.

Viewing files on an external USB storage device

To view files on an external USB storage device, simply plug the device into the **USB A** jack on the display, and then go to the **EZ Media > USB** menu to view the files.

Supported file formats

• Photo:

Format	Max Resolution
JPEG	1920 x 1080
BMP	1920 x 1080

• Audio:

Format	Sample Rate (KHz)	Bit Rate (Kbps)
MP1/MP2/MP3	8-48	8-320
OGG	8-48	64-320
ADPCM-WAV	8-48	32-384
PCM-WAV	8-48	128-1536
AAC	8-48	8-256

• Video:

Format	Video Codec	Max Resolution	Frame rate (fps)	Bitrate (Mbps)	Audio Codec
.avi .divx	MJPEG	1920 x 1080	30	30	
	H.264/AVC (Supports < 6 reference frames)	1920 x 1080	30		AC3 (AC3-HD not supported)
	DivX 4/5/6	1920 x 1080	30	25	DTS (DTS-HD not supported)
	XVID	1920 x 1080	30	30	MPEG-1, Layer I,II
	MPEG2 (1080i not supported)	1920 x 1080	30	30	MPEG-1, LayerIII (mp3)
	MPEG4 (B Frame not supported)	1920 x 1080	30	30	PCM ADPCM AAC
.dat .vob .mpg .mpeg	VC-1 (Advance Profile not supported)	1920 x 1080	30	25	
	MPEG1 (D-picture not supported)	1920 x 1080	30	30	MPEG-1, Layer I,II MPEG-1, LayerIII (mp3) AC3 (AC3-HD not supported) DTS (DTS-HD not supported)
.mov .mp4	MPEG2	1920 x 1080	30	30	LPCM
	MPEG4 (B Frame not supported)	1920 x 1080	30	25	AAC AMR
.rm .rmvb	H.264/AVC (Supports < 6 reference frames)	1920 x 1080	30	30	PCM ADPCM
	RV3	1920 x 1080	30	30	Cook (RA6) RAAC (RA9)
	RV4	1920 x 1080	30	30	RACP (RA10)

• **Office Viewer:**

- Adobe PDF: accepts file size up to 75MB
PDF 1.0/1.1/1.2/1.3/1.4
- Microsoft Word: accepts file size up to 100MB
British Word 95/Word 97/2000/2003/2007 (.docx)/2010 (.docx)
- Microsoft Excel: accepts file size up to 15MB
British Excel 5, 95, Excel 97/2000/2002/2003/2007 (.xlsx)/2010 (.xlsx), Office XP Excel
- Microsoft PowerPoint: accepts document page number up to 1000, and file size up to 19MB
British PowerPoint 97, PowerPoint 2000/2002/2003/2007 (.pptx)/2010 (.pptx), Office X
PowerPoint, PowerPoint presentation-2003 and earlier (.ppx), PowerPoint Presentation-
2007 and 2010 (.ppsx)

Photo

Supported photo files will appear as thumbnails on the screen. You can use the remote control to select and view a photo and perform other additional operations.

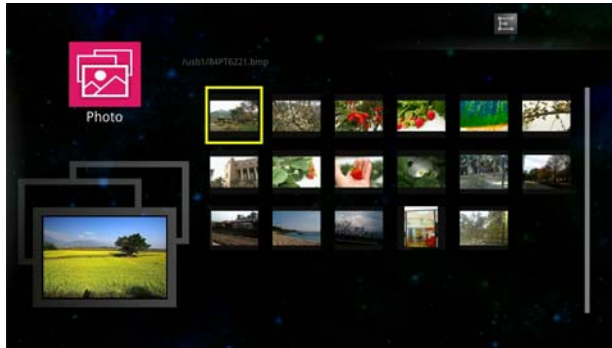









Remote control button functions in thumbnail view:

No	Name	Description
1	HOME	Goes back to the main page.
2	ESC	Goes back to the previous page.
3	ENTER	Opens the selected photo.
4	←/↑/↓/→ (PREV) (NEXT)	Directional arrows for selecting a desired photo.
5	REV	
6	▶/	N/A
7	■	
8	FWD	



Remote control button functions in browse mode:

No	Icon	Description
1	 (Rotate)	<ol style="list-style-type: none"> 1. Press ← or → to highlight this icon, and then press ENTER. 2. Press ← or → to rotate the photo counterclockwise or clockwise (0 > 90 > 180 > 270 degrees). 3. To return to normal view, press ESC.
2	 (Zoom)	<ol style="list-style-type: none"> 1. Press ← or → to highlight this icon, and then press ENTER. 2. Press ENTER to zoom in on the photo. 3. Press ←/↑/↓/→ to pan the enlarged photo. <small>(PREV) (NEXT)</small> 4. To return to normal view, press ESC.
3	 (Previous)	Goes to previous photo.
4	 (Next)	Goes to next photo.
5	 (Slideshow)	Displays all photos in a slideshow. Press ESC/ENTER/← / ↑ / ↓ / → to go back to the browse mode. <small>(PREV) (NEXT)</small>
6	 (Delete)	Press ENTER and then ↑ / ↓ to delete the photo.
7	 (Copy)	<p>Press ENTER and then ↑/↓ to copy the photo to the display's internal memory.</p> <p>Note:</p> <ul style="list-style-type: none"> • You can only copy photos from an external USB storage device to the display's internal memory. Copying of audio, video and document files is not supported.
8	 (Information)	Displays information of the current photo.
9	 (Back)	Returns to the previous page.

Video

Supported video files will appear in the list on the screen. You can use the remote control to select and play a video file and perform other additional operations.

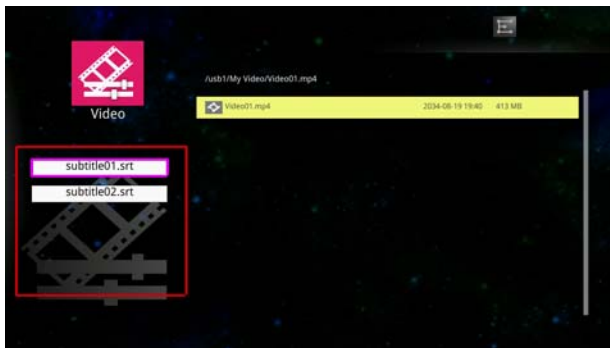
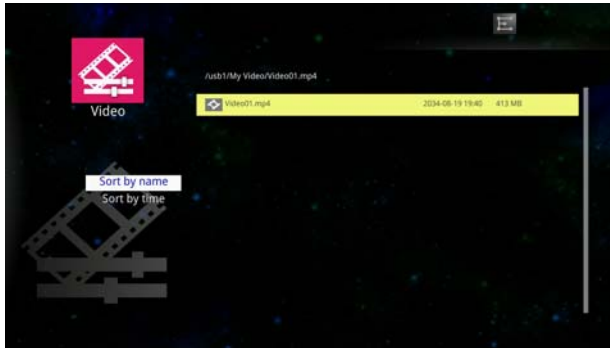

Remote control button functions in list view

No	Name	Description
1	HOME	Goes back to the main page.
2	ESC	Goes back to the previous page.
3	ENTER	Plays selected video file.
4	←/↑/↓/→ (PREV) (NEXT)	<ul style="list-style-type: none"> ↑ / ↓ : Moves the highlight bar up/down to select a file. ← : Sorts video files by file name (alphabetically) or created time. → : Shows subtitle files for the selected video file.
5	REV	
6	▶/	N/A
7	■	
8	FWD	

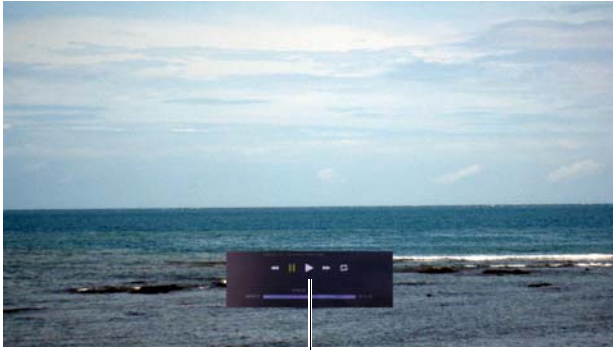

Playback controls panel

Remote control button functions: when the playback controls panel is displayed

No	Name	Description
1	HOME	Goes back to the main page.
2	ESC	<ul style="list-style-type: none"> • Hides the control user interface when the video is playing. • Goes back to the previous page when the video is not playing.
3	ENTER	Plays/pauses the video.
4		<ul style="list-style-type: none"> • ↑ / ↓ : N/A • ←: Goes to the previous video file. • →: Goes to the next video file.
5	REV	Rewinds the video. Press repeatedly to change the speed at 1X, 2X, 4X or 8X.
6	▶/	Plays/pauses the video.
7	■	Stops playing the video.
8	FWD	<p>Fast forwards the video. Press repeatedly to change the speed at 1X, 2X, 4X or 8X.</p> <p>Note: When fast-forwarding videos in .rmvb format, slight delay may occur due to the decoding process.</p>

Remote control button functions: when the playback controls panel is hidden

No	Name	Description
1	HOME	Goes back to the main page.
2	ESC	Goes back to the previous page.
3	ENTER	Displays the playback controls panel.
4		<ul style="list-style-type: none"> • ↑ / ↓: N/A • ←: Goes to the previous video. • →: Goes to the next video.
5	REV	
6	▶/	Displays the playback controls panel.
7	■	
8	FWD	

Audio

Supported audio files will appear in the list on the screen. You can use the remote control to select and play an audio file and perform other additional operations.

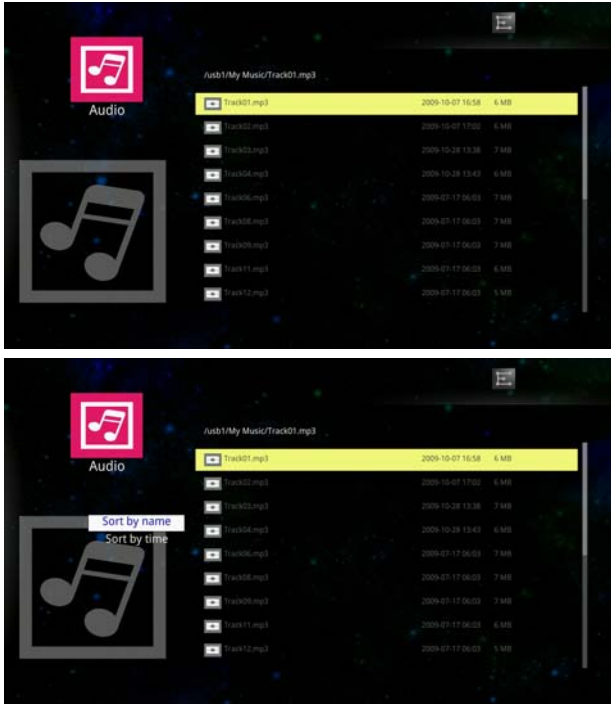

Remote control button functions in list view:

No	Name	Description
1	HOME	Goes back to the main page.
2	ESC	Goes back to the previous page.
3	ENTER	Opens the selected audio file.
4		<ul style="list-style-type: none"> • ↑ / ↓ : Moves the highlight bar up/down to select a file. • ← : Sorts audio files by file name (alphabetically) or created time. • → : N/A
5	REV	
6	▶/	N/A
7	■	
8	FWD	



Remote control button functions during playback:











No	Name	Description
1	HOME	Goes back to the main page.
2	ESC	Goes back to the previous page.
3	ENTER	Plays/pauses the audio.
4		<ul style="list-style-type: none"> • ↑ / ↓ : N/A • ← : Plays the previous audio file. • → : Plays the next audio file.
5	REV	Rewinds the audio.
6	▶/	Plays/pauses the audio.
7	■	Stops playing the audio.
8	FWD	Fast forwards the audio.

Office Viewer







You can use the **Office Viewer** to view PowerPoint, Word, Excel and PDF files. Select the document you want to view and perform the functions as provided on the screen according to your needs.



Remote control button functions in list view:

No	Name	Description
1	HOME	Goes back to the main page.
2	ESC	Goes back to the previous page.
3	ENTER	Opens the selected file.
4	    (PREV) (NEXT)	<ul style="list-style-type: none"> •  /  : Moves the highlight bar up/down to select a file. •  : Sorts files by file name (alphabetically) or created time. •  : N/A
5	REV	
6		N/A
7		
8	FWD	

Remote control button functions when a document is opened:

No	Name	Description
1	HOME	Goes back to the main page.
2	ESC	Closes the document.
3	ENTER	Zooms in to the maximum view or zooms out to the minimum view.
4		<ul style="list-style-type: none"> • : Moves to the top of the page or goes back to the previous page. • : Moves to the bottom of the page or goes to the next page. • : Moves to the left/right of the page.
5	REV	Goes back to the previous page.
6		N/A
7		
8	FWD	Goes to the next page.

Settings

You can change settings for the **EZ Media** and **EZ Display** functions in the **Settings** menu.

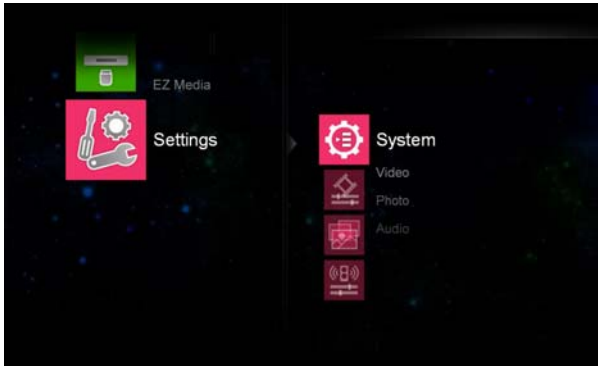

Item	Description
System	<ul style="list-style-type: none"> • Version: Shows firmware version number. • Language: Sets a preferred language for the OSD menu. • Update: Allows you to update the firmware of the EZ Media and EZ Display functions using a USB flash drive. • Hostname: Shows the name of display for network identification. • USBConnect: When the display is connected to a computer via a USB cable, enable this function and a Removable Disk icon will appear on the computer for file transfer. • Auto Play Mode: You can set the display to automatically play photo, video or audio files. If this function is enabled, the display will play files on the USB flash drive automatically after the drive is connected to the display. To get back to multi-media menu when auto play mode is on, press the following in keys in order: REV, ▶/ , and ■.
Video	<ul style="list-style-type: none"> • Display Ratio: Sets the screen aspect ratio when playing video. • Repeat Mode: Sets the repeat mode for playing video. If On is selected, only current video file will be repeated. If Off is selected, all video files in current folder will be repeated sequentially.
Photo	<ul style="list-style-type: none"> • Display Ratio: Sets the screen aspect ratio when playing photos. • Slideshow Duration: Sets the length of time between each photo in the slideshow mode.
Audio	<ul style="list-style-type: none"> • Repeat Mode: Sets the repeat mode for playing audio. If Off is selected, only current audio file will be repeated. If On is selected, all audio files in current folder will be repeated sequentially.

Product information

Specifications

	Item	Specifications		
		PS4652	PS5552	PS6552
LCD panel	Backlight	E-LED		
	Panel size	46"	55"	64.53"
	Pixel pitch (mm)	0.53025 x 0.53025	0.21 x 0.63	0.744 x 0.744
	Native resolution (pixels)	1920 x 1080		
	Brightness (cd/m ²) (typical)	500	500	450
	Contrast (typical)	4000:1		
	Adaptive Contrast	30000:1	65000:1	7700:1
	Response time (ms) (typical)	6.5		8
Input	Panel Bit	10-bit (8 bit + FRC), 1073.7M		
	Computer	VGA (D-Sub 15-pin), DVI (DVI-D), DisplayPort		
	Video	YPbPr (RCA jacks), HDMI		
	Audio	Line-in (3.5 mm Mini-jack)		
	USB	Type A; Mini B		
Output	Control	RS-232C (D-Sub 9-pin), LAN (RJ45 jack)		
	Computer	VGA (D-Sub 15-pin)		
	Video	N/A		
	Speaker	N/A		
	Audio	Line-out (3.5 mm Mini-jack)		
Audio	Control	RS-232C (D-Sub 9-pin)		
	Audio W (Amp)	10W x 2		
	Internal speaker	10W x 2		
Power	Supply	100 - 240V AC, 50/60 Hz		
	Consumption Max.	135W	165W	300W
	Consumption Standby	< 0.5W		
Environment	Operating Temperature	0°C - 40°C, 32°F - 104°F		
	Operating Humidity	20% - 80% (without condensation)		
	Storage Temperature	-20°C - 60°C, 4°F - 140°F		
	Storage Humidity	5% - 95% (without condensation)		
	Display Orientation	Landscape/Portrait		
Mechanical	Weight (kg)	21.1	28.3	50
	Dimensions (W x H x D) (mm)	1047.4 x 575.9 x 50	1239.2 x 710 x 50	1521.2 x 882.8 x 81.6
	Bezel Dimension - T/B/L/R (mm)	13.05/13.05/13.05/13.05	13.2/13.2/13.2/13.2	37.3/37.3/44.3/44.3
Feature	VGA daisy chain	○		
	DVI daisy chain	○		
	RS232 control daisy chain	○		
	ID setting	○		
	Sharpness enhancement	○		
	Proof of image retention	○		
Dimming control (Adaptive Contrast)	○			

Picture in Picture (PIP)	○
Picture by Picture (PBP)	○
10 Bit color processing	○
Built-in video wall support	○
Scheduling	○
Total turn-on time	○
Diagnostic DC voltage (12V/ 5V)	○
Internal temperature Sensor	○
CEC control	○



The terms HDMI and HDMI High-Definition Multimedia Interface, and the HDMI Logo are trademarks or registered trademarks of HDMI Licensing LLC in the United States and other countries.

Notes:

- Specifications and functions are subject to change without notice.
- ○: supported, Blank: not supported

Dimensions

PS4652

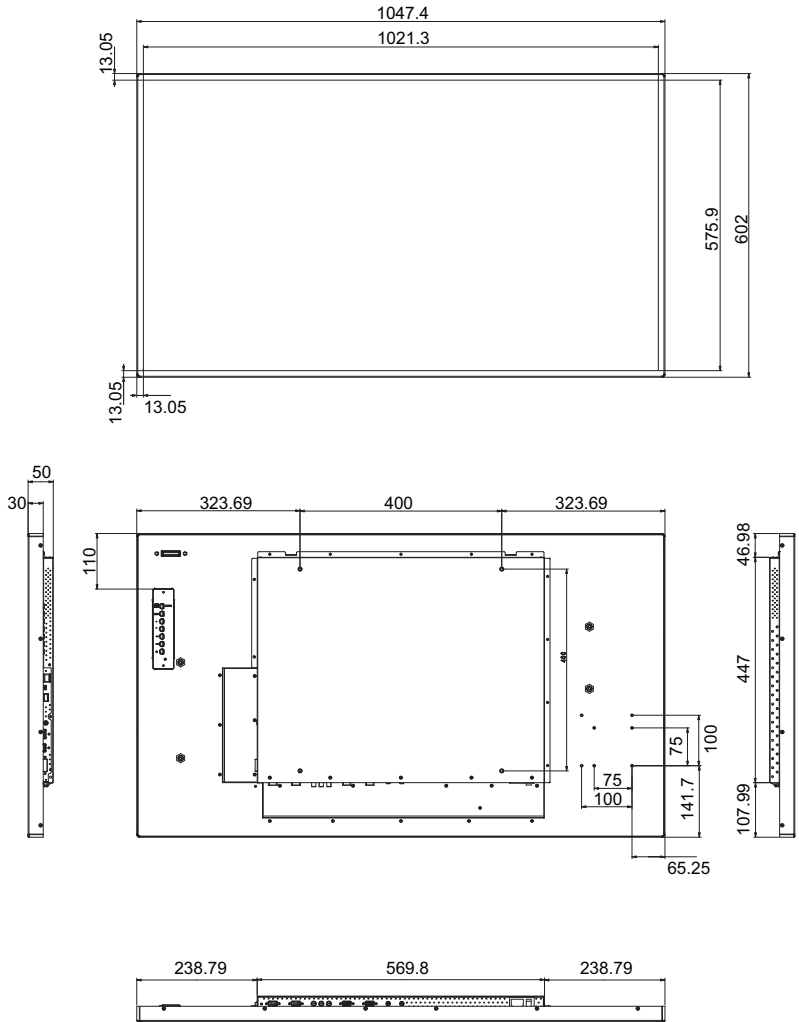

Unit: mm

PS5552

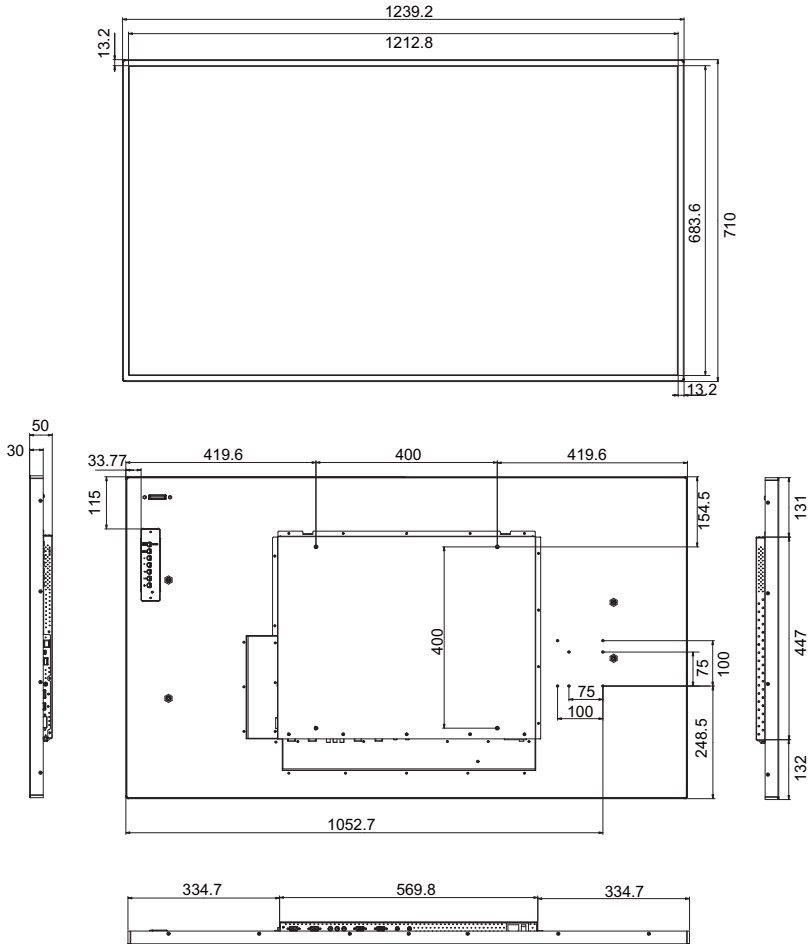

PS6552

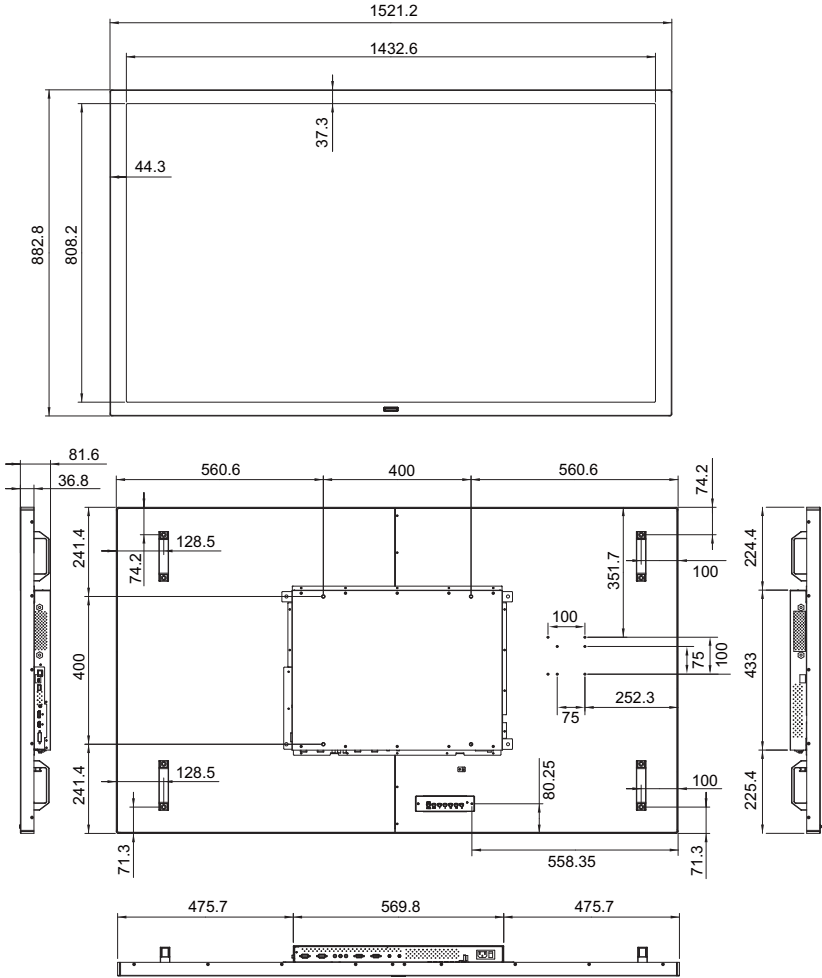

Unit: mm

Remote control codes

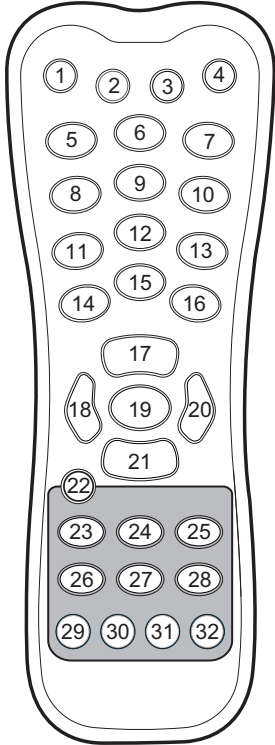

No.	Function	Customer code	Hex code
1	OFF	00	0D
2	INPUT	00	0B
3	INFO	00	22
4	ON	00	0C
5	1/VGA	00	01
6	2/DVI	00	02
7	3/DP	00	03
8	4/HDMI-1	00	04
9	5/HDMI-2	00	05
10	6/SDI	00	06
11	7/AV	00	07
12	8/YPbPr	00	08
13	9/MULTI-MEDIA	00	09
14	EXIT	00	28
15	0/MUTE	00	00
16	MENU	00	0F
17	Up	00	20
18	Left/VOL-	00	11
19	ENTER	00	0A
20	Right/VOL+	00	10
21	Down	00	21
22	HOME	0x41BE	0x0BF4
23	ESC	0x41BE	0x01FE
24	Up	0x41BE	0x0AF5
25	ENTER	0x41BE	0x0FF0
26	Left/Previous	0x41BE	0x13EC
27	Down	0x41BE	0x0CF3
28	Right/Next	0x41BE	0x03FC
29	Reverse	0x41BE	0x15EA
30	Play/Pause	0x41BE	0x10EF
31	Stop	0x41BE	0x07F8
32	Forward	0x41BE	0x05FA

Supported input signal resolution

		Resolution	Pixel Rate (MHz)	Input source				
				VGA	DVI	Display Port	HDMI	YPbPr
1	RGB	640x480 @ 60Hz (VGA)	25.175	○	○	○	○	
2		640x480 @ 72Hz	31.500	○	○	○	○	
3		640x480 @ 75Hz	31.500	○	○	○	○	
4		720x400 @ 70Hz	28.320	○	○	○	○	
5		800x600 @ 60Hz (SVGA)	40.000	○	○	○	○	
6		800x600 @ 75Hz	49.500	○	○	○	○	
7		1024x768 @ 60Hz (XGA)	65.000	○	○	○	○	
8		1024x768 @ 75Hz	78.750	○	○	○	○	
9		1280x720 @ 60Hz	74.25	○	○	○	○	
10		1280x768 @ 60Hz	68.25		○	○	○	
11		1280x800 @ 60Hz RB (WXGA)	71.000	○	○	○	○	
12		1280x800 @ 60Hz (WXGA)	83.500	○	○	○	○	
13		1280x960 @ 60Hz	108.000	○	○	○	○	
14		1280x1024 @ 60Hz (SXGA)	108.000	○	○	○	○	
15		1360x768 @ 60Hz	85.500	○	○	○	○	
16		1366x768 @ 60Hz (HD)	85.500	○	○	○	○	
17		1400x1050 @ 60Hz	121.750	○	○	○	○	
18		1600x1200 @ 60Hz	162.000	○	○	○	○	
19		1680x1050 @ 60 Hz RB (WSXGA)	119.000	○	○	○	○	
20		1680x1050 @ 60Hz (WSXGA)	146.250	○	○	○	○	
21		1920x1080 @ 60Hz (FHD)	148.500	○	○	○	○	
22	SD	480i (60Hz)	25.175				○	○
23		576i (50Hz)	31.500				○	○
24		480p (60Hz)	31.500		○	○	○	○
25		576p (50Hz)	28.320		○	○	○	○
26	HD	720p (25Hz)	74.250		○	○	○	○
27		720p (30Hz)	74.250		○	○	○	○
28		720p (50Hz)	40.000		○	○	○	○
29		720p (60Hz)	49.500		○	○	○	○
30		1080i (50Hz)	65.000			○	○	
31		1080i (60Hz)	78.750			○	○	○
32		1080p (24Hz)	74.250		○		○	○

33	HD	1080p (25Hz)	74.250		○		○	○
34		1080p (30Hz)	74.250		○	○	○	○
35		1080p (50Hz)	79.500		○	○	○	○
36		1080p (60Hz)	71.000		○	○	○	○
37		1080p (24Psf)						○
38		1080p (25Psf)						○

Notes:

- ○: supported
- Blank: not supported

Supported PAP input signal combination

		Main/Left picture signal source					
		YPbPr	VGA	DVI	HDMI	DisplayPort	Multi-media
Sub/Right picture signal source	YPbPr			○	○	○	○
	VGA			○	○	○	○
	DVI	○	○			○	
	HDMI	○	○			○	
	Display Port	○	○	○	○		○
	Multi-Media	○	○			○	

Notes:

- ○: supported
- Blank: not supported

Troubleshooting

Problem	Solution
No picture	Check the following: <ul style="list-style-type: none"> • Is the display turned on? Check the power indicator of the display. • Is the signal source device turned on? Turn on the device and try again. • Are there any loose cable connections? Make sure that all cables are connected firmly. • Have you chosen an unsupported output resolution on the computer? Refer to Supported input signal resolution on page 59 to select a supported resolution and try again. • Have you chosen an unsupported output resolution on the DVD or Blu-ray disc player? Refer to Supported input signal resolution on page 59 to select a supported resolution and try again.
No sound	Check the following: <ul style="list-style-type: none"> • Have you turned on the mute function on the display or the input source device? Turn off the mute function or increase the audio volume level and try again. • Are there any loose cable connections? Make sure that all cables are connected firmly.
The computer input image looks strange	<ul style="list-style-type: none"> • Have you chosen an unsupported output resolution on the computer? Refer to Supported input signal resolution on page 59 to select a supported resolution and try again. • Use the Auto Adjustment function (See Adjust Screen on page 37) to let the display automatically optimize the display of computer image. • If the result of the Auto Adjustment function is not satisfactory, use the Clock Frequency, Phase, H. Position and V. Position functions to manually adjust the image.
The control panel buttons do not work	Have you locked the control panel buttons? Unlock the buttons and try again.
The remote control does not work	<ul style="list-style-type: none"> • Have you locked the remote control function? Unlock the function and try again. • Check for incorrect battery orientation. • Check for dead batteries. • Check your distance and angle from the display. • Check whether remote control is properly being pointed at the display's remote control sensor window. • Check for any obstacle between the remote control and the remote control sensor window. • Check that the remote control sensor window is not under strong fluorescent lighting, or in direct sunlight. • Check for any devices (computer or personal digital assistant, PDA) nearby that transmit infrared signals which may cause interference to signal transmission between the remote control and the display. Turn off the infrared function of these devices.