

FHD - 2.5K - 4K
NVIDIA 3D Vision Replacement

NOVACAST



3D PluraView

The Reference for 3D-Stereo Monitors



- Flicker-free for continuous, professional use
- Highest brightness – Daylight suitable
- Two assembly sizes – 22"/24" and 27"/28"
- Wide Viewing Angle – Group interaction
- Certified for Photogrammetry, VR and GIS
- Resolutions in FullHD, 2.5K or 4K (UHD)



3D Display Excellence – High-end PluraView Stereo

Flicker-free and high-resolution visualization for the perfect 3D stereo experience

Our innovative and reliable PluraView beam-splitter technology is the basis for pixel-precise, stereoscopic 3D image displays, offering the highest stereo viewing quality possible. Currently, PluraView stereo displays can be configured with screen diagonals of up to 28", resolutions up to 4K (UHD) and a color depth of 10-bit per pixel.

In addition, our new BlackTuner technology substantially enhances the viewing and capturing of dark, shadowed image areas and comes integrated with the 27" and 28" 3D PluraView monitors.

With screen refresh rates of only 1ms, a blur-free image display for motion videos and smooth stereo image roaming is guaranteed. Our optimized polarization glasses feature excellent stereo channel separation to prevent "ghosting" and are inexpensive and easy to replace, if scratched or damaged. The high-quality, passive stereo-viewing environment offers the user a comfortable and fatigue-free work experience for all 3D stereo applications.

3D PluraView - The Reference for 3D-Stereo Displays

- Flicker-free for relaxed 3D operations and continuous, professional use
- Highest brightness – suitable for office daylight conditions, one monitor per stereo channel and each eye
- Wide viewing angle – suitable for group viewings with up to 5 people
- Highest resolution - up to 4K (UHD / 8.3 MPx per eye) @ 10-bit color depth
- Certified for Photogrammetry and GIS (ESRI, HEXAGON, TRIMBLE, AGISOFT, etc.)
- Functional design - highest quality - Made in Germany
- 'Plug & Play' technology established for the past 14 years!

Designed for 3D Professionals























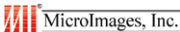















The optimum 3D-Stereo experience – all day long!

The Schneider Digital 3D PluraView monitors feature optimized beam-splitter technology for the highest quality in stereoscopic rendering on the desktop. Our 3D PluraView monitors are ideally suited for all stereo software applications from most major industries, such as:

- GIS & 3D Mapping
- Photogrammetry & LiDAR
- Oil & Gas prospecting & simulation
- 3D City modeling / BIM
- Computer tomography & surgical planning
- Biochemistry / Stereo-Microscopy
- 3D Molecular research and design
- Crystallography / Biochemistry
- CGI / 3D Video editing
- Mechanical Design / CAx
- Industrial Measuring / Laser Scanning
- Simulation & VR training
- Archeology

Any software that supports Nvidia 3D Vision Pro works 'plug & play' with the 3D PluraView.

Some 3D PluraView supported applications:

 3D Zephyr	 Summit Evolution	 Stereo Analyst	 ESPA 3D	 ArcGIS Pro
 ArcGIS Pro	 StereoCAD	 Photomod	 Metashape	 Socet Set / Socet GXP
 SCI-X	 GeoMedia	 WinATLAS	 TNTgis	 3DM Content Manager
 uSMART	 Match-AT / DTMaster / UASMaster	 ContextCapture	 Vr Two	 LIMON Viewer PRO
 Scene	 CloudCompare Stereo	 TerraStereo	 LaserControl	 RhinoTerrain
 Softplotter / KDSP	 ERDAS IMAGINE	 ImageStation	 VirtouZo	 HxMap
 Digi3D	 PurVIEW	 Gcarto	 Petrel	 VoxelGeo
 GoCAD	 GeoProbe	 Kingdom	 JewelSuite	 HydroVish

3D PLURAVIEW MONITOR SPECIFICATIONS

	22" FHD	24" FHD
Display	21.5" (546 mm) Screen Size 2x 1,920 x 1,080 Resolution (2.1 MP) 16.7 Million Colors (8-bit) 250 cd/m ² Brightness	24" (610 mm) Screen Size 2x 1,920 x 1,080 Resolution (2.1 MP) 16.7 Million Colors (8-bit) 350 cd/m ² Brightness
	LED BackLit-Technology 2 ms Response Time 170°/160° Viewing Angle (H/V)	LED BackLit-Technology 1 ms Response Time 170°/160° Viewing Angle (H/V)
	Contrast Ratio: 200,000: 1 ACR	Contrast Ratio: 1,000 : 1 static
Frame Rate	60 Hz	144 Hz
3D-Characteristics	160 cd/m ² Brightness with glasses 1,920 x 1,080 per eye resolution	210 cd/m ² Brightness with glasses 1,920 x 1,080 per eye resolution
	Linear Polarization 45°/135° beam-splitter: 50%-transparency, polarized mirror	
3D-Formats	Quad Buffered OpenGL, Side-by-Side, Top-Bottom, Quad-Buffered DirectX	
Operating Systems	Windows / Linux / macOS-Compatibility, Windows-10 Certification	
Power Consumption	Power Consumption 53W typical; max. 1W in Power Management Mode; Annual Power Consumption 94 kWh / year	Power Consumption 61W typical; max. 1W in Power Management Mode; Annual Power Consumption 135 kWh / year
	Power Management VESA DPMS™, Energy Star 6.0 Efficiency Class B	
Weight	23 kg system weight with stand	26 kg system weight with stand
Measurements	54 x 59 x 46 cm (W x H x D)	61 x 60 x 49 cm (W x H x D)
Interfaces	2x DisplayPort 1.1 cable 2.5m (integrated)	2x DisplayPort 1.2 cable 2.5m
	1 x main plug AC 100 - 240 V, 50 / 60 Hz	
Audio	Integrated Speakers 2 x 2 W	
Design	Diamond Dark Alu/Steel Construction Integrated Electronics Adjustable Stand Made in Germany	
Technical Notes	2x DisplayPort 1.1 output from the graphics card is required, optionally available as dual DVI version	2x DisplayPort 1.2 output from the graphics card is required for 144Hz; with DP 1.1 output - 120Hz screen refresh. FreeSync support with AMD graphics cards
Graphics Card Requirements	Any Quad-Buffer capable NVIDIA Quadro and AMD FirePRO / RadeonPRO cards, which have at least 2x DisplayPort 1.1 monitor outputs. It is recommended to use an additional side monitor for the 3D PluraView system, which is adapted to the polarization of the stereo system.	
Warranty	1 year manufacturer warranty, with optional carepack extended up to 5 Years	



3D PluraView supporting
QuadBuffer Graphics Cards

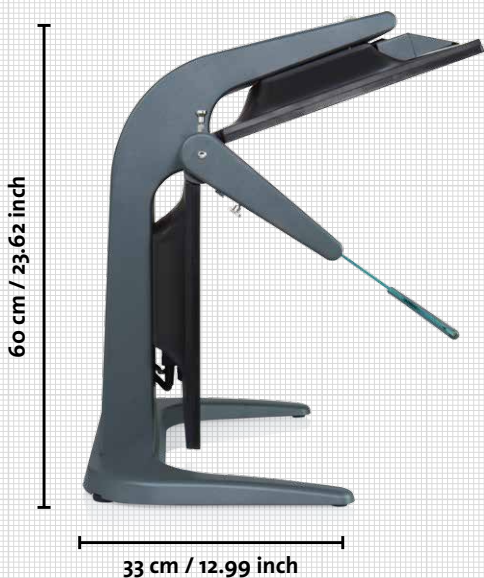

3D PluraView
FHD

3D PLURAVIEW MONITOR SPECIFICATIONS

	27" 2,5K	28" 4K/UHD
Display	27" (686 mm) Screen Size 2x 2,560 x 1,440 Resolution (3.7 MP) 16.7 Million Colors (8-bit) 350 cd/m ² Brightness	28" (711 mm) Screen Size 2x 3,840 x 2,160 Resolution (8.3 MP) 1,073 Billion Colors (10-bit*) 300 cd/m ² Brightness
	LED BackLit-Technology 1 ms Response Time 170 °/160 ° Viewing Angle (H/V) BlackTuner for enhancement of shadow areas	
	Contrast Ratio: 80,000,000 : 1 ACR	Contrast Ratio: 12,000,000 : 1 ACR
Frame Rate	60 Hz	60 Hz
3D-Characteristics	210 cd/m ² Brightness with glasses 2,560 x 1,440 per eye resolution	180 cd/m ² Brightness with glasses 3,840 x 2,160 per eye resolution
	Linear Polarization 45°/135° beam-splitter: 50%-transparency, polarized mirror	
3D-Formats	Quad-Buffered OpenGL, Side-by-Side, Top-Bottom, Quad Buffered DirectX	
Operating Systems	Windows / Linux / macOS-Compatibility, Windows-10 Certification	
Power Consumption	Power Consumption 75W typical; max. 1W in Power Management Mode; Annual Power Consumption 131 kWh / year	Power Consumption 98W typical; max. 1W in Power Management Mode; Annual Power Consumption 173 kWh / year
	Power Management VESA DPMS™, Energy Star 6.0 Efficiency Class B	
Weight	25 kg system weight with stand	26 kg system weight with stand
Measurements	80 x 68 x 54 cm (W x H x D)	80 x 68 x 54 cm (W x H x D)
Interfaces	2x DisplayPort 1.2 cable 3m 2x USB 2.0	2x DisplayPort 1.2 cable 3m 2x USB 3.0
	1 x main plug AC 100 - 240 V, 50 / 60 Hz with power switch and fuse 3.15 A	
Audio	Integrated Speakers 2 x 2.5 W	Integrated Speakers 2 x 3 W
Design	Diamond Dark Aluminum Construction Integrated Electronics Adjustable Stand Made in Germany	
Technical Notes	2x DisplayPort 1.1 output from the graphics card is required AMD FreeSync support graphics cards	2x DisplayPort 1.2 output from the graphics card is required for 60Hz; with DP 1.1 output - 30Hz screen refresh. AMD FreeSync support graphics cards
Graphics Card Requirements	Any Quad-Buffer capable NVIDIA Quadro and AMD FirePRO / RadeonPRO cards, which have at least 2x DisplayPort 1.1 monitor outputs. It is recommended to use a side monitor for the 3D PluraView system, which is adapted to the polarization of the stereo system. * The feature 10-bit color depth with Quad-Buffer 3D stereo only works with AMD graphics cards.	
Warranty	1 year manufacturer warranty, with optional carepack extended up to 5 Years	

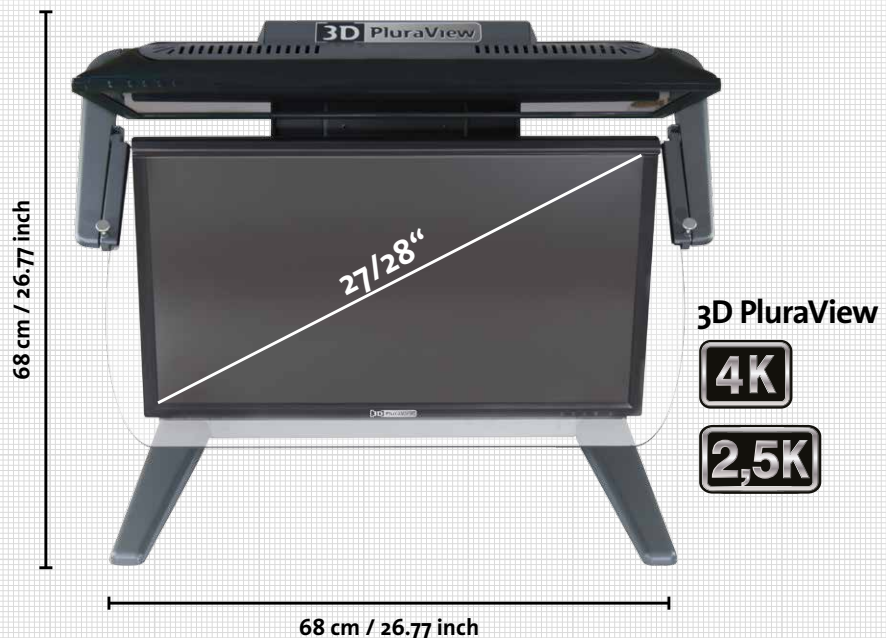
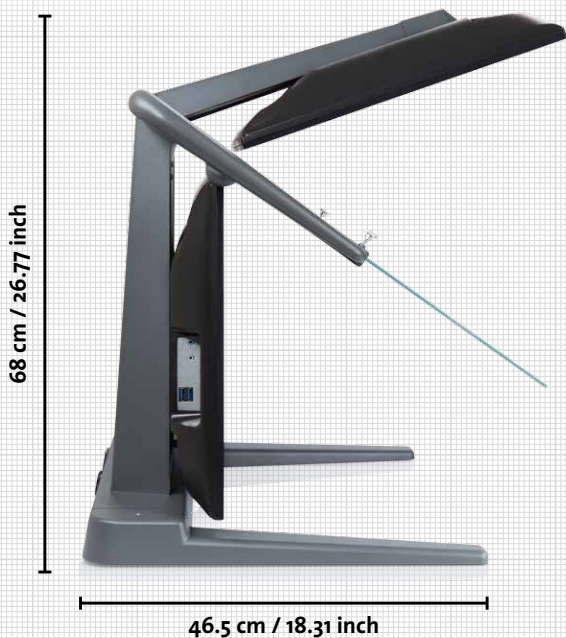



The reference for passive 3D-Stereo Monitors

3D PluraView Stereo Monitors – Meeting the highest requirements for GIS, VR and 3D Imaging

Especially with GIS and photogrammetry applications, professional users are faced by the challenge of quickly loading large amounts of data and visualizing these in stereoscopic mode on a 3D-capable system. Professionals who are working daily with high-resolution 3D mesh models, stereo imagery, CAD and GIS data, need a flicker-free, daylight-capable 3D monitor, which allows fatigue-free, stereoscopic interaction all day long.

Schneider Digital has introduced the 3D PluraView family of beam-splitter, passive 3D stereo displays, to meet these exact needs. 3D PluraView monitors are specifically designed for stereoscopic display, interfacing seamlessly to most 3D-capable software applications in photogrammetry, for LiDAR point clouds, CAD, GIS and BIM, but also for medical 3D data visualization. Only with cross-polarized, passive stereo filters, can stereo images, intricate CAD, mesh and other surfaces and textures be reproduced down to the smallest detail.

3D PluraView - Advantages & Benefits

- Passive stereo monitors have the highest user acceptance of any 3D display technology available.
- The long-term experience of our users, some working with our beam-splitter systems for more than 14 years, proves the high quality and user-friendliness.
- Due to their high brightness, 3D PluraView users can work in normal daylight office conditions.
- Our flicker-free, bright and clear 3D-stereo displays substantially increase user motivation and productivity.
- The new 3D PluraView models with full 4K stereo resolution enable and innovate the stereo display of 3D city models, BIM, LiDAR data and all medical 3D applications.
- NEW! Professional alternative to HMD devices:
VR PluraView with Head & Object Tracking now available!

Certified for geospatial software

3D PluraView applications and examples



Trimble DTMaster



Terrasolid TerraStereo

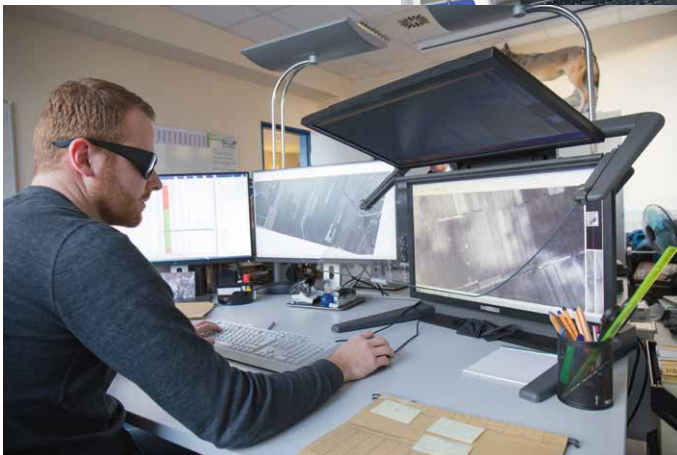

Erdas Stereo Analyst for ArcGIS



esri ArcGIS Pro



DAT/EM Summit Evolution



Hexagon GeoMedia



RhinoTerrain



3D PluraView – Key Functionalities

With the involvement of our experienced users, our engineers further developed and improved upon the beam-splitter technology of the original PLANAR systems:

- State-of-the-art DisplayPort 1.2 mirror card with Free-Sync / G-Sync / ULMB support guarantees a synchronous, latency-free image signal with up to 4K resolution and 10-bit color depth.
- Our custom mirror card is integrated in the 3D PluraView system, allows full stereo functionality connected to a Laptop workstation with certified graphics card.
- Negligible stereo cross-talk due to precisely adapted screen and beam-splitter hardware, combined with optimized polarization glasses.
- Innovative BlackTuner technology substantially enhances the viewing and capturing of dark, shadowed image areas on 27" and 28" models.
- Central power supply with integrated power switch for complete power separation, therefore zero Watt power consumption when switched off (27" and 28" models).
- Precision adjustment of the beam-splitter mirror for exact stereo image overlay.
- Highest product quality - Made in Germany.

Limitations of alternative 3D-Displays

- The active shutter technology of LCD - glasses produces a much darker stereo image.
- High-frequency LCD shuttering puts strain on the eyes and leads to rapid fatigue; Low brightness requires darkened rooms; Neon light amplifies LCD flickering!
- NVIDIA's "3D Vision" with LCD glasses and emitter is no longer supported by the manufacturer, mostly out-of-stock and broken NVIDIA glasses cannot be replaced;
- Anaglyph displays are restricted to non-professional, simple stereo viewing. All color representation is distorted by anaglyph glasses with red-blue filters, resulting also in a dark, low-contrast stereo impression;
- Circular polarization displays reduce the stereo resolution by 50% in horizontal direction, as each image is displayed by alternate lines on the monitor. Fonts and menus are difficult to read at half resolution! Pixel-accurate work is virtually impossible, and the additional polarization filter, which is attached to the monitor, reduces the stereo image brightness substantially.



Choose the reference in stereo visualization!

High-Performance Workstations

Since 1995, Schneider Digital has been specializing in tailor-made hardware solutions for professional 3D graphic applications. The company's expertise is focused on the development, configuration and build of high-performance workstations, which excel by the combined quality of their components. Our flexible configuration options and long-term upgradeability protect your investment!

We collaborate closely with most major hardware component manufacturers, software companies and independent research institutes. We get first-hand, immediate knowledge about the most recent developments. Equally valuable to us is the close contact to our users. Together, this results in 'workstation solutions from practical experience for practical applications'.

Especially with GIS and photogrammetry applications, professional users are faced by the challenge of having to load huge amounts of data quickly. Sometimes several Terabytes per RGB image, then visualize these image pairs in stereoscopic mode! Only if all hardware components harmonize perfectly, is it possible to work without display delays and enjoy smooth, fast stereo roaming.

We do not have just superficial knowledge about the main software applications for CAD, Photogrammetry or GIS, but work closely with many software manufacturers. We collaborate with them right up to the creation of meshed 3D city models, BIM, architecture designs, digital terrain models and in special tasks such as 3D point cloud editing and terrestrial photogrammetry.



All our workstations feature additional sound isolation and customized (water) cooling solutions to maintain performance and minimize sound emissions.



High-end workstations for demanding computation and stereo display requirements

- Newest Intel® Xeon®, AMD EPYC™ or AMD Ryzen™ Threadripper™ Processor technology.
- Up to four high-end graphics cards for CUDA or OpenCL applications in one workstation.
- High-speed processors (up to 2x 56 Cores on Intel platform, up to 2x 64 cores with AMD EPYC).
- Up to 8 TB fast DDR-4 ECC memory.
- Latest U.2 NVMe SSDs with 32Gbit/s interface and up to 15 Terabyte per drive in a super-fast, internal high-performance RAID configuration with more than 120TB in one logical drive volume. Configuration of M.2 NVMe together with SAS 3.0 drives is possible.
- Optional, ultra-fast 10GB/s LAN for connection to file servers.
- Absolute top quality for all components.
- 19" Rackmount compatible.
- Custom server and cluster solutions available.



High-end graphics cards

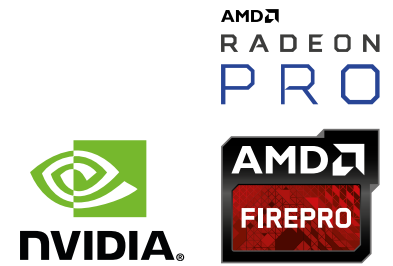

AMD RadeonPRO WX9100 and NVIDIA Quadro RTX 5000

The right choice of graphics cards is instrumental for your productivity and quality of work. With 16GB of superfast HBM2 ECC RAM, OpenGL 4.6 support and 4,096 OpenCL-enabled, parallel processing cores, the AMD FirePRO WX9100 provides excellent performance and scalability to handle very large data sets for analysis and visualization.

The six monitor outputs on the AMD RadeonPRO WX9100 allow you to control simultaneously two monoscopic monitors and a 3D PluraView stereo seat with just one graphics card. Even two 3D PluraView stereo monitors can be operated simultaneously with this solution.

All stereo graphics cards from AMD and NVIDIA are suitable for multi-monitor operation.

The NVIDIA Quadro RTX 5000 delivers outstanding performance and quality with up to 3,072 CUDA/OpenCL programmable, parallel processing cores and an ECC, GDDR6 graphic memory of 16GB. The Quadro RTX 5000 is the perfect solution for complex applications such as biomedical sciences and seismic research, oil and gas subsurface simulation and of course also for photogrammetry and all other geospatial data applications.

The use of the correct driver is just as important, because only the optimum interaction between graphics card, the driver and application ensures full graphics card performance. It takes constant optimization of hardware drivers to guarantee smooth operations with perfect results, explaining the immense development effort by AMD and NVIDIA.

From OpenGL3.3, the size of the graphics card memory is highly relevant, as entire 3D models may be loaded and GPU computations are therefore executed much faster.

Doubling the graphic memory improves the efficiency of GPU computations up to 40% for large 3D models! Fewer mesh-model tiles have to be dynamically loaded/unloaded and also fewer tile-overlaps have to be processed.



3D-Stereo mouse devices

The perfect measurement devices for GIS, photogrammetry and 3D mapping

3D-Stereo mouse systems are ergonomic, high performance 3D controllers to increase productivity and comfort while working with demanding 3D applications. With up to 10 freely programmable buttons, the user has a maximum of 32 functions and macros literally 'at his fingertips'. This enables efficient operations in GIS and photogrammetry applications, increasing efficiency and helping to reduce fatigue.

Functions & advantages

- USB – 'plug-and-play' compatibility; COM-port versions still available.
- Supported by ALL photogrammetry software applications.
- Made in USA with patented designs.
- Schneider Digital is the official warranty, sales & service center Europe for STEALTH
- Comfortable, ambidextrous usability for GIS, photogrammetry and surveying applications.
- The optical XY mouse with its high-resolution laser works excellently on all non-reflective surfaces and requires no maintenance.
- The Z-wheel with a resolution of 1024 steps per rotation allows fast and accurate measurements.
- Programmable buttons with tested 10 million clicks ensure a long service life.



 *Stealth 3D Mouse*



softmouse 3D



Support for ALL Windows, Linux & MacOS operating systems, both 32 & 64 bit.



High Resolution
FullHD, 2.5K or 4K
per eye



Flicker Free
for continuous,
professional use



Daylight Suitable
with two bright and
high-contrast displays



Wide Viewing Angle
for comfortable work
even in a team



Compact Design
Two different assembly sizes
for optimal space utilization



Functional Design
Highest quality -
Made in Germany



Supported Graphics Cards
all NVIDIA Quadro &
all AMD FirePRO / RadeonPRO



Plug & Play
Works without driver under
Microsoft / LINUX / macOS



Software Certified
for all 3D stereo
applications



NovaCast Systems AB

Fridhemsvägen 8, Soft Center 1
372 38 Ronneby, SWEDEN

Tel.: +46 (0) 457 46 58 00

E-mail: info@novacast.se

Internet: www.novacast.se



3D PluraView

www.3d-pluraview.com