

FHD - 2.5K - 4K  
NVIDIA 3D Vision Replacement



# 3D PluraView

## The Reference for 3D-Stereo Monitors



- Flicker-free for continuous, professional use
- Highest brightness – Daylight suitable
- Two assembly sizes – 22"/24" and 27"/28"
- Wide Viewing Angle – Group interaction
- For Geo, Oil & Gas, Medical, BioChem, etc.
- Resolutions in FullHD, 2.5K or 4K (UHD)



## 3D Display Excellence – High-end PluraView Stereo

Flicker-free and high-resolution visualization for the perfect 3D stereo experience

Our 3D PluraView System provide the optimum stereo-viewing environment for a comfortable and fatigue-free work experience with all 3D-stereo applications.

Our innovative and reliable PluraView beam-splitter technology is the basis for pixel-precise, stereoscopic 3D image displays, offering the highest stereo viewing quality possible. Currently, PluraView stereo displays can be configured with screen diagonals of up to 28", resolutions up to 4K (UHD) and a color depth of 10-bit per pixel.

In addition, our new BlackTuner technology substantially enhances the viewing and capturing of dark, shadowed image areas and comes integrated with the 27" and 28" 3D PluraView monitors.

With screen refresh rates of only 1 ms, an absolutely smooth stereo image roaming is guaranteed. Our optimized polarization glasses feature excellent stereo channel separation to prevent "ghosting" and are inexpensive and easy to replace, if scratched or damaged.

### 3D PluraView - The Reference for 3D-Stereo Displays

- Flicker-free for relaxed 3D operations and continuous, professional use
- Highest brightness – suitable for office daylight conditions, one monitor per stereo channel and each eye
- Free and wide viewing angle – suitable for group viewings with up to 5 people
- Highest resolution - up to 4K (UHD) with 8.3 MegaPixel per eye at 10-bit color depth
- Certified for several hundred applications (PDF listed on 3D-Pluraview.com)
- Engineered and manufactured with the highest quality in Germany
- Future-proof and established for more than 17 years as plug & play technology
- Our best stereo-reference are many long-term and highly satisfied users



# Designed for 3D Professionals

The optimum 3D-Stereo experience – all day long!

The Schneider Digital 3D PluraView monitors feature optimized beam-splitter technology for the highest quality in stereoscopic rendering on the desktop. Our 3D PluraView monitors are ideally suited for all stereo software applications from most major industries, such as:

- GIS & 3D Mapping
- Photogrammetry & LiDAR
- Oil & Gas Prospecting & Simulation
- Mine Planning and Open-Pit Monitoring
- 3D City Model Visualization
- BIM and Architecture Modeling
- Flow & Light Simulation
- Computer Tomography & Surgical Planning
- Biochemistry / Stereo-Microscopy
- Pharmaceutical research
- Crystallography / Molecular research
- CGI / 3D Video editing
- Mechanical Design / CAD / CAM
- Industrial Measuring / Laser Scanning / Tomography
- Simulation & VR training
- Archeology, cultural heritage documentation

Any software that supports Nvidia 3D Vision Pro works 'plug & play' with the 3D PluraView.

## 3D PluraView compatible applications:

 3D Zephyr	 Summit Evolution	 Stereo Analyst	 ESPA 3D	 ArcGIS Pro
 ArcGIS Pro	 StereoCAD	 Photomod	 Metashape	 Socet Set / Socet GXP
 Sci-X	 GeoMedia	 WinATLAS	 TNTgis	 3DM Content Manager
 uSMART	 Match-AT / DTMaster / UASMaster	 ContextCapture	 Vr Two	 LiMON Viewer PRO
 Scene	 CloudCompare Stereo	 TerraStereo	 LaserControl	 RhinoTerrain
 Softplotter / KDSP	 ERDAS IMAGINE	 ImageStation	 VirtouZo	 HxMap
 Digi3D	 PurVIEW	 Gcarto	 Petrel	 VoxelGeo

The current and up-to-date list of 3D PluraView-supported software applications is available for download at:  
<https://www.3d-pluraview.com/en/application-field>



**Software Certified**  
for all 3D stereo  
applications

[List of all Applications >](#)



### 3D PLURAVIEW MONITOR SPECIFICATIONS

	22" FHD	24" FHD
Display	21.5" (546 mm) Screen Size 2x 1,920 x 1,080 Resolution (2.1 MP) 16.7 Million Colors (8-bit) 250 cd/m <sup>2</sup> Brightness	24" (610 mm) Screen Size 2x 1,920 x 1,080 Resolution (2.1 MP) 16.7 Million Colors (8-bit) 350 cd/m <sup>2</sup> Brightness
	LED BackLit-Technology 2 ms Response Time 170°/160° Viewing Angle (H/V)	LED BackLit-Technology 1 ms Response Time 170°/160° Viewing Angle (H/V)
	Contrast Ratio: 200,000: 1 ACR	Contrast Ratio: 1,000 : 1 static
Frame Rate	60 Hz	144 Hz
3D-Characteristics	160 cd/m <sup>2</sup> Brightness with glasses 1,920 x 1,080 per eye resolution	210 cd/m <sup>2</sup> Brightness with glasses 1,920 x 1,080 per eye resolution
	Linear Polarization 45°/135° beam-splitter: 50%-transparency, polarized mirror	
3D-Formats	Quad Buffered OpenGL, Side-by-Side, Top-Bottom, Quad-Buffered DirectX	
Operating Systems	Windows / Linux / macOS-Compatibility, Windows-10 und Windows-11 Certification	
Power Consumption	Power Consumption 53W typical; max. 1W in Power Management Mode; Annual Power Consumption 94 kWh / year	Power Consumption 61W typical; max. 1W in Power Management Mode; Annual Power Consumption 135 kWh / year
	Power Management VESA DPMS™, Energy Star 6.0 Efficiency Class B	
Weight	23 kg system weight with stand	26 kg system weight with stand
Measurements	54 x 59 x 46 cm (W x H x D)	61.5 x 61.5 x 47.5 cm (W x H x D)
Interfaces	2x DisplayPort 1.1 cable 2.5m	2x DisplayPort 1.2 cable 2.5m
	1 x main plug AC 100 - 240 V, 50 / 60 Hz	
Audio	Integrated Speakers 2 x 2 W	
Design	Diamond Dark Alu/Steel Construction Integrated Electronics Adjustable Stand Made in Germany	
Technical Notes	2x DisplayPort 1.1 output from the graphics card is required, optionally available as dual DVI version	2x DisplayPort 1.2 output from the graphics card is required for 144Hz; with DP 1.1 output - 120Hz screen refresh. FreeSync support with AMD graphics cards
Graphics Card Requirements	Any Quad-Buffer capable NVIDIA Quadro and AMD FirePRO / RadeonPRO cards, which have at least 2x DisplayPort 1.1 monitor outputs. It is recommended to use an additional side monitor for the 3D PluraView system, which is adapted to the polarization of the stereo system.	
Warranty	1 year manufacturer warranty, with optional carepack extended up to 5 Years	

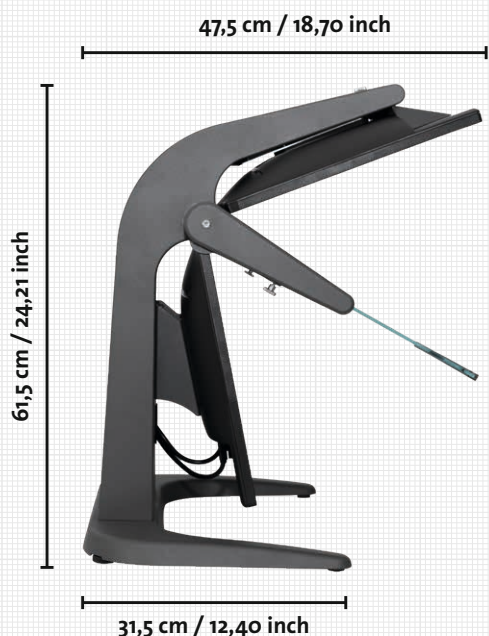

**Supported Graphics Cards:**  
All NVIDIA Quadro & all  
AMD FirePRO / RadeonPRO

[List of all cards >](#)



### 3D PLURAVIEW MONITOR SPECIFICATIONS

	27" 2,5K	28" 4K/UHD
<b>Display</b>	27" (686 mm) Screen Size 2x 2,560 x 1,440 Resolution (3.7 MP) 16.7 Million Colors (8-bit) 350 cd/m <sup>2</sup> Brightness	28" (711 mm) Screen Size 2x 3,840 x 2,160 Resolution (8.3 MP) 1,073 Billion Colors (10-bit*) 300 cd/m <sup>2</sup> Brightness
	LED BackLit-Technology 1 ms Response Time 170°/160° Viewing Angle (H/V) BlackTuner for enhancement of shadow areas	
	Contrast Ratio: 80,000,000 : 1 ACR	Contrast Ratio: 12,000,000 : 1 ACR
<b>Frame Rate</b>	60 Hz	60 Hz
<b>3D-Characteristics</b>	210 cd/m <sup>2</sup> Brightness with glasses 2,560 x 1,440 per eye resolution	180 cd/m <sup>2</sup> Brightness with glasses 3,840 x 2,160 per eye resolution
	Linear Polarization 45°/135° beam-splitter: 50%-transparency, polarized mirror	
<b>3D-Formats</b>	Quad-Buffered OpenGL, Side-by-Side, Top-Bottom, Quad Buffered DirectX	
<b>Operating Systems</b>	Windows / Linux / macOS-Compatibility, Windows-10 und Windows-11 Certification	
<b>Power Consumption</b>	Power Consumption 75W typical; max. 1W in Power Management Mode; Annual Power Consumption 131 kWh / year	Power Consumption 98W typical; max. 1W in Power Management Mode; Annual Power Consumption 173 kWh / year
	Power Management VESA DPMS™, Energy Star 6.0 Efficiency Class B	
<b>Weight</b>	25 kg system weight with stand	26 kg system weight with stand
<b>Measurements</b>	80 x 68 x 56 cm (W x H x D)	80 x 68 x 56 cm (W x H x D)
<b>Interfaces</b>	2x DisplayPort 1.2 cable 3m 2x USB 2.0	2x DisplayPort 1.2 cable 3m 2x USB 3.0
	1 x main plug AC 100 - 240 V, 50 / 60 Hz with power switch and fuse 3.15 A	
<b>Audio</b>	Integrated Speakers 2 x 2.5 W	Integrated Speakers 2 x 3 W
<b>Design</b>	Diamond Dark Aluminum Construction Integrated Electronics Adjustable Stand Made in Germany	
<b>Technical Notes</b>	2x DisplayPort 1.1 output from the graphics card is required AMD FreeSync support graphics cards	2x DisplayPort 1.2 output from the graphics card is required for 60Hz; with DP 1.1 output - 30Hz screen refresh. AMD FreeSync support graphics cards
<b>Graphics Card Requirements</b>	Any Quad-Buffer capable NVIDIA Quadro and AMD FirePRO / RadeonPRO cards, which have at least 2x DisplayPort 1.1 monitor outputs. It is recommended to use a side monitor for the 3D PluraView system, which is adapted to the polarization of the stereo system. * The feature 10-bit color depth with Quad-Buffer 3D stereo only works with AMD graphics cards.	
<b>Warranty</b>	1 year manufacturer warranty, with optional carepack extended up to 5 Years	

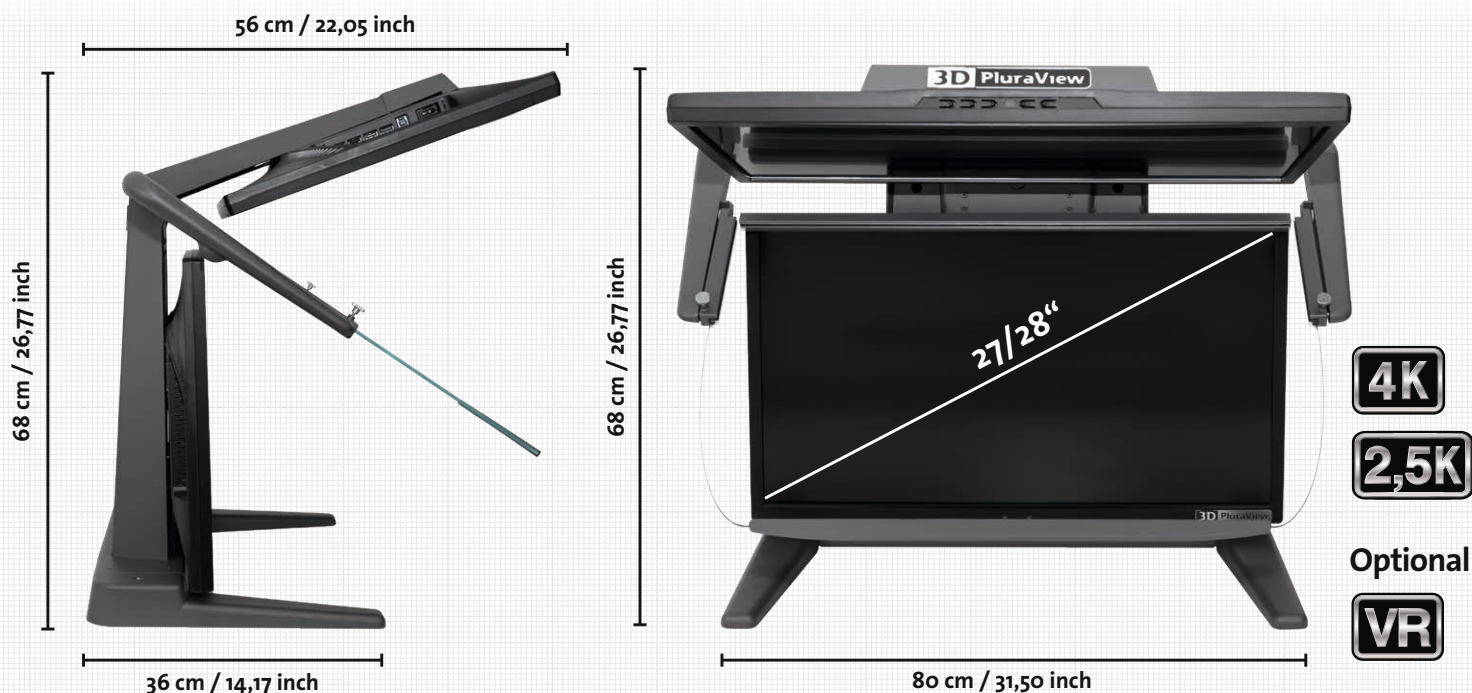



## The reference for Passive 3D-Stereo Monitors

3D PluraView Systems – Meeting the highest requirements for GIS, VR and 3D Imaging

Especially with geospatial applications, professional users are faced by the challenge of quickly loading large amounts of data and visualizing these in stereoscopic mode on a 3D-capable system. Professionals who are working daily with high-resolution 3D mesh models, LiDAR point clouds, stereo imagery, CAD and GIS data, need a flicker-free, daylight-capable 3D monitor, which allows fatigue-free, stereoscopic interaction all day long. Only with cross-polarized, passive stereo filters, can stereo images, intricate CAD, mesh and other surfaces and textures be reproduced down to the smallest detail. Schneider Digital as introduced the 3D PluraView family of beam-splitter, passive 3D stereo displays, to meet these professional requirements in an ideal way. They can be used Plug & Play with all 3D stereo-capable software applications.

### 3D PluraView - Advantages & Benefits:

- Passive stereo monitors have the highest user acceptance of any 3D display technology available.
- The long-term experience of our users, some working with our beam-splitter systems for more than 17 years, proves the high quality and user-friendliness.
- Due to their high brightness, 3D PluraView users can work in normal daylight office conditions.
- Our flicker-free, bright and clear 3D-stereo displays substantially increase user motivation and productivity.
- 3D PluraView systems are designed specifically for stereo, however, they are 100% usable also as a normal, monoscopic desktop monitor
- The 4K stereo resolution enables the representation of the finest textures and object details, e.g. for 3D city models, for BIM / CAx / CGI projects and LiDAR point clouds. Especially relevant is 4K resolution for medical 3D applications, for CT and MRI scans and 3D object-printing.
- NEW! Professional alternative to immersive head-mounted devices: VR PluraView with Head & Object Tracking



# Certified for geospatial software

3D PluraView applications and examples

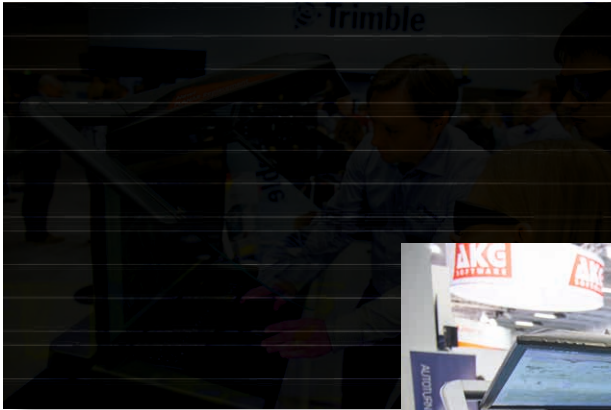

Trimble DTMaster



Terrasolid TerraStereo

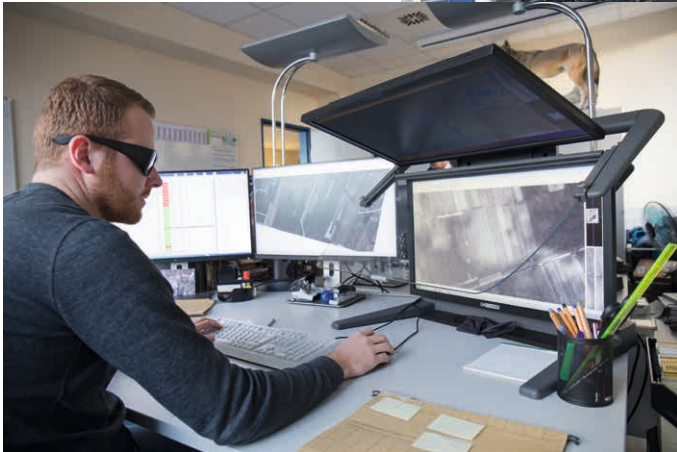

Erdas Stereo Analyst for ArcGIS



esri ArcGIS Pro



DAT/EM Summit Evolution



Hexagon GeoMedia



RhinoTerrain





### 3D PluraView – Key Functionalities and Advantages

With the involvement of our experienced users, our engineers further developed and improved upon the beam-splitter technology of the original PLANAR systems:

- Supported operating systems: Windows 11, LINUX & macOS / remote (e.g. Teradici)
- Our specifically developed DisplayPort 1.2 mirror cards with Free-Sync / G-Sync / ULMB support guarantee a synchronous, latency-free image signal with up to 4K resolution and 10-bit color depth.
- The mirror cards are integrated in the 3D PluraView systems and allow full stereo functionality with a laptop computer and certified graphics card.
- The precise, pixel-accurate calibration of the 3D PluraView systems enables the perfect and simultaneous display of stereoscopic and monoscopic applications in full screen resolution.
- Negligible stereo cross-talk due to precisely adapted screen and beam-splitter hardware, combined with optimized polarization glasses.
- Innovative BlackTuner technology substantially enhances the viewing and capturing of dark, shadowed image areas on 27" and 28" models.
- Central power supply with integrated power switch for complete power separation, therefore zero Watt power consumption when switched off (27" and 28" models).
- Precision adjustment of the beam-splitter mirror for exact stereo image overlay.
- Highest product quality - Made in Germany.

### Limitations of alternative 3D-Displays

- The active shutter technology of LCD - glasses produces a much darker stereo image.
- High-frequency LCD shuttering puts strain on the eyes and leads to rapid fatigue. Low brightness requires darkened rooms. Neon light substantially amplifies flickering!
- NVIDIA's "3D Vision" kit with LCD glasses, emitters and integrated graphic card drivers are no longer supported by the manufacturer and new items are out-of-stock.
- Anaglyph glasses with red-blue filters and false-color image display are equally distressing for longer-term usage. Moreover, a dark image with poor contrast is displayed.
- Circular polarization displays reduce the stereo resolution by 50% in vertical direction, as each stereo image is displayed by alternate lines on the screen. Fonts and menus are very difficult to read at half resolution! Pixel-accurate work is virtually impossible, and the additional polarization filter substantially reduces image brightness.
- Active stereo systems cannot handle standard side-by-side stereo or top-bottom outputs. This limits the usability.

**Choose the reference in stereo visualization!**



# Performance-Workstations

Schneider Digital has specialized in customized hardware solutions for professional 3D graphics applications since 1995. Our focus for the configuration and build of high-performance workstations and servers is on uncompromising quality and perfect matching of all components. We guarantee a reliable, long service life with the option to upgrade individual components at a later stage.

Through our close cooperation with hardware manufacturers, software companies, universities and research institutes, we have first-hand knowledge about the latest hardware and software developments. Equally important to us is the close and trusted contact to our global hardware customers. This extensive knowledge-base is really key to building workstation solutions that are tailored to your specific requirements, meet and exceed your expectations.

The challenge for geospatial applications is the combination of loading large amounts of data quickly and visualizing them stereoscopically on a suitable 3D monitor. Latency-free work with extensive 3D-stereo datasets, such as detailed, large-area 3D models is only possible, if all hardware and software components are perfectly matched.

**AMD**  
**RYZEN**  
THREADRIPPER



Thanks to additional sound insulation and special cooling solutions, our workstations are also very pleasant office „companions“.

## High-End workstation solutions for complex geospatial requirements

- Latest Intel XEON, AMD EPYC or AMD Ryzen Threadripper PRO technology
- High clock-speed processors (up to 2x 38 cores on the Intel XEON platform, up to 2x 64 cores with AMD Threadripper PRO and EPYC)
- Up to 4-TB fast DDR4 ECC RAM
- Up to four (4x) high-end graphic cards for AI, CUDA and OpenCL applications in a single workstation
- High-performance NVMe RAID with write and read speeds of more than 25,000 MB/s and 256-TB internal SSD storage capacity
- Optional, ultra-fast 100-GbE LAN connection
- IPMI interface for secure and complete remote workstation management
- 19" rack-mount solutions, also for distributed cluster processing
- We use only highest-quality components



# High-End graphics cards

Schneider Digital has more than 25 Years of experience recommending and configuring professional graphic cards for our customer base. We have been pioneers in the graphics card market and were indeed the first reseller for both NVIDIA and AMD graphic cards in Europe.

High-End graphic cards, such as the quad-buffered AMD Radeon Pro W6800 or the NVIDIA RTX A6000 feature between 32GB and 48GB of memory, which accelerates parallel processing tasks substantially due to increased tile-size per computation unit. Such high-end cards can also be stacked, i.e. multiple graphic cards can be integrated in our Schneider Digital workstations. Often, this approach provides the optimum price-performance balance for our customers, based on their specific throughput and computation requirements.

The six 4K monitor outputs on the AMD Radeon PRO W6800 allow you to control simultaneously four monoscopic monitors and a dual-screen 3D PluraView stereo seat with just one graphics card. Even two 3D PluraView stereo monitors with side-screens can be operated simultaneously with this solution.

The development of professional software applications makes increasing use of parallel computing on the GPU and fast GDDR/HBM memory resources that high-end



graphic cards offer. A prime and highly visible example are AI applications with neural networks to be trained and then unleashed on massive amounts of video and still-imaging datasets for pattern/object recognition, achieving matching results nearly in real-time.

Serious, GPU-intensive tasks in the geospatial domain are for instance image matching and georeferencing and the computation of high-resolution 3D mesh models. Such typical tasks can efficiently be computed in parallel by GPU Tensor Cores (NVIDIA) and their equivalent-functionality Stream Processors (SP's) on AMD cards. The latest generation graphic cards support PCIe 4.0, doubling the data bandwidth compared to the previous PCIe 3.0 standard. Doubling the graphics memory improves the efficiency of GPU computations by up to 40% for large 3D models! Larger raster tiles can be loaded and therefore less overlapping information has to be processed.



## Supported Graphics Cards:

All NVIDIA Quadro & all  
AMD FirePRO / RadeonPRO

[List of all cards >](#)



All quad-buffer graphics cards from AMD and NVIDIA are suitable for multi-monitor operations.





# 3D-Controller

Perfect measuring instruments for GIS, photogrammetry and mapping

3D controllers, also known as ‚3D mice‘, are high-performance, ergonomic interfaces, designed to increase productivity and comfort when interacting with stereoscopic image-pairs in 3D-stereo. With up to 10 freely programmable buttons, the user can benefit from 32 commands and macros on different access layers without having to take the hands off the controller. Even in combination with a ‚normal‘ mouse, 3D controllers are optimally designed to support 3D visualization and digitization functions in the field of GIS, photogrammetry, mapping and surveying.

## Functions & Benefits

- Supported by ALL photogrammetry software applications
- Comfortable, double-handed usability for GIS, photogrammetry and surveying applications
- The Z-wheel with a resolution of 1024 steps per rotation enables a fast and precise measuring function
- High-precision X-Y laser navigation for precise position control.
- Long-life buttons with tested 10 million actuations ensure a long service life.



 *Stealth 3D Mouse*



[More Information >](#)



[More Information >](#)



3Dconnexion controllers have their origins in robotics and space exploration and are leading the way for all 3D model interaction requirements. The controllers offer simultaneous navigation cursor movement with six degrees of freedom via the central joy-stick, enabling a fluid, dynamic 3D data presentation in “fly-through” mode. Precise and rapid navigation with the 3Dconnexion controller also permits a much faster access to 3D model components that can then be modified with the standard two-button mouse. Their robust and durable industrial design makes them a powerful tool for all 3D applications. The simultaneous, two-handed use of a 3Dconnexion controller for 3D model interaction and navigation together with a standard mouse, offers substantial improvements in workplace ergonomics and productivity.

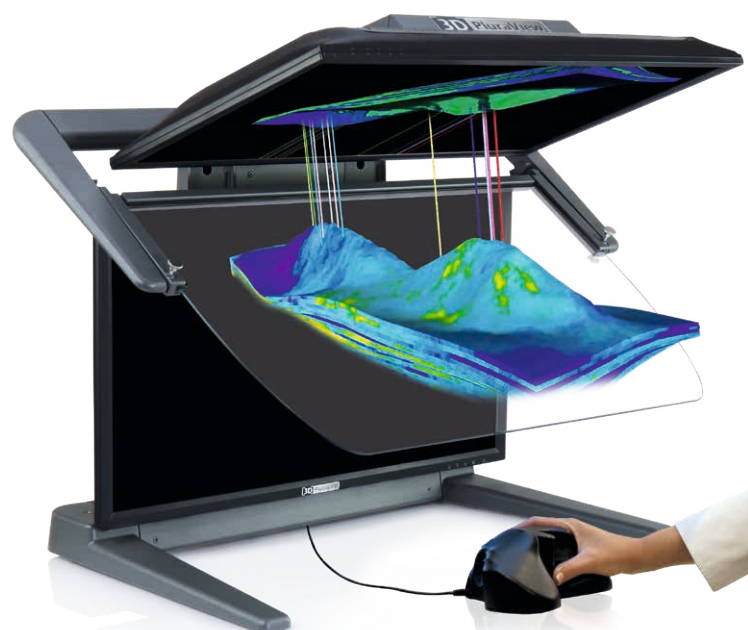



## 3D PluraView - The Reference for passive 3D-Stereo Monitors

With over 3,000 units of the 3D PluraView systems currently in use worldwide, the PluraView monitors are compatible with over 300 stereo-enabled software applications. They are the market leader and established reference for professional 3D-stereo visualization.



High Resolution



Flicker Free



Daylight Suitable



Wide Viewing Angle

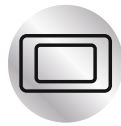

Compact Design



Functional Design / Highest quality



NVIDIA & AMD supported

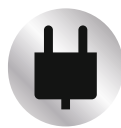

Plug & Play



Software Certified



Ambit Geospatial Solution  
2806 Hong Kong Plaza,  
186-191 Connaught Road West,  
HONG KONG

Tel.: (+852) 3462 3320  
E-Mail: [eric.yau@ambit-geospatial.com.hk](mailto:eric.yau@ambit-geospatial.com.hk)  
Internet: [www.ambit-geospatial.com.hk](http://www.ambit-geospatial.com.hk)



**3D PluraView**

[www.3d-pluraview.com](http://www.3d-pluraview.com)